

See discussions, stats, and author profiles for this publication at: <https://www.researchgate.net/publication/221787566>

# Design Considerations for Long Endurance Unmanned Aerial Vehicles

Chapter · January 2009

DOI: 10.5772/6482 · Source: InTech

---

CITATIONS

21

---

READS

4,250

3 authors:



**Johan Meyer**

University of Johannesburg

77 PUBLICATIONS 240 CITATIONS

SEE PROFILE



**Francois du Plessis**

University of Johannesburg

13 PUBLICATIONS 88 CITATIONS

SEE PROFILE



**WA Clarke**

Calebyte

81 PUBLICATIONS 392 CITATIONS

SEE PROFILE

# Design Considerations for Long Endurance Unmanned Aerial Vehicles

Johan Meyer, Francois du Plessis and Willem Clarke  
*University Johannesburg*  
*South Africa*

## 1. Abstract

The arena of Unmanned Aerial Vehicles (UAVs) has for many years been dominated by the defence industries. The reason for this can be attributed to the complexity and cost of designing, constructing and operating of these vehicles. An additional contributing factor is the legislative issues around operating an unmanned aircraft in civilian airspace. However in recent years advances in micro-electronics especially Micro Electronic Mechanical Systems (MEMS) and advanced composite manufacturing techniques have placed the design and construction of UAVs in the domain of the commercial civilian users. A number of commercial UAV applications have emerged where the legislative requirements for operating of a UAV in segregated airspace can be met. UAVs are extremely well suited for the dull, dirty and dangerous tasks encountered in performing surveying and surveillance applications. For these tasks the primary design considerations in the design of the UAV would be the propulsion system, the guidance and control system and the payload system.

## 2. Introduction

The European Unmanned Vehicle Association identifies five main categories of UAVs (Sarris, 2001):

- **Close range** – fly in a range of less than 25 km. Usually extremely light;
- **Short range** – operate within a range of 25-100km.
- **Medium range** – Able to fly within a range of 100-200km. Need more advanced aerodynamic design and control systems due to their higher operational performance.
- **Long range** – Fly within a range of 200-500km. Require more advanced technology to carry out complex missions. Need satellite link in order to overcome the communication problem between the ground control systems and aircraft created by the curvature of the earth.
- **Endurance** – Operate in a range more than 500km, or can stay in the air for more than 20 hrs. This is considered the most sophisticated of the UAV family due to their high capabilities.

This chapter presents design considerations for UAVs which can be categorized as endurance UAVs. The design considerations discussed include the primary UAV systems namely, propulsion system, navigation and control system and sensor payload system.

Renewable energy sources is an attractive alternative to the conventional fossil fuel based propulsion systems. The renewable energy sources evaluated for long endurance UAV applications include solar energy, hydrogen fuel cells and energy storage sources such as batteries and super capacitors. The advantages and disadvantages of each source are presented. Results from an algorithm developed for the selection of the optimal energy source based upon the application requirements and constraints are presented. Implementation issues around a solar powered UAV for long endurance applications are discussed. The results of the feasibility study of using solar power for long endurance UAVs are presented.

Advances in the development of MEMS based inertial sensors have enabled the development of low cost inertial navigation systems for use in UAV applications. An overview of the field on inertial navigation is presented along the advances in inertial sensors. Some considerations that impact the selection of the inertial sensors and the final design of the navigation system are presented. A number of options for the improvement of the navigational performance of the low-cost inertial sensors by combining the sensor data with the measurements from other sensors such as GPS, cameras and altimeters are discussed.

Another aspect of UAV design is the control system. Autonomous control is of paramount importance for the safe and successful operation of unmanned aircraft that is operated out of visual range. The development of UAV autopilots is presented by looking at the classical and the modern approaches to control system development.

UAVs are extremely well suited for applications where the payload consists of optical image sensors such as cameras. Cameras offer powerful lightweight sensors suited for a variety of tasks. In keeping with commercial trends (in contrast to the military environment) some of the functionality associated with the operation of long range UAVs can be "outsourced" by using existing infrastructure. This effectively increases the risk of an unsuccessful UAV mission (in a commercial sense), but lowers the cost of development and operations.

Image processing solutions invariably implies large processing power, which leads to high power requirements. By using the pervasiveness and low cost of the mobile communications technology and industry, some of the processing can be "outsourced" to a powerful ground processing station. This opens up a Pandora's box of opportunities, i.e. real-time scene identification, automated mission control, visual cues, speed and orientation estimations, super resolution of low resolution sensory information, etc. Recent trends see high speed, parallel processing Graphics Processing Units (GPU) integrated into low powered mobile phones. This can provide high speed processing power on-board the UAV for complex image processing applications. A balance need to be maintained between local, on-board processing requirements (e.g. for reliable navigational purposes) and higher level functionality (associated with the mission).

The next section presents the design considerations for long endurance UAV applications with regard to renewable energy propulsion sources, navigation and control aspects and payload applications.

### **3. Electrical Power Sources for Long Endurance UAV Applications**

Unmanned Aerial Vehicles are ideally suited for long endurance applications, but to be able to make full use of this feature, effective power sources need to be developed to ensure the long endurance functionality of the propulsion system and onboard equipment. For a UAV the flight endurance is in direct relationship to the total weight of the craft. In order to maximise flight endurance the need for high density energy sources are created. The

objective of this section is to present design considerations for high energy density, cost effective, non-carbon emitting and renewable energy sources. The following energy sources and combinations thereof are considered:

- Lithium Polymer (Li-Po) Batteries;
- Super Capacitors (SC);
- Photo Voltaic (PV) Cells; and
- Hydrogen Fuel (FC) Cells.

Lithium Polymer batteries and super capacitors are in essence only energy storage mediums. However in the context of UAV power sources these energy stores can be considered as energy sources for supplying power to the UAV and associated onboard equipment.

### 3.1 Solar Energy

Solar energy refers to the solar power collected from solar irradiance by photovoltaic cells. The power output of photovoltaic cells depends primarily on the absolute value and spectral distribution of irradiance in the plane of the photovoltaic cell and the resulting operational temperature (Luque & Hegedus, 2003). Much research has been conducted with regards to the factors influencing solar power generation which is beyond the scope for this chapter. The total amount of energy produced by the photovoltaic cells is a function of the geographical position (latitude, longitude, and altitude), time of the year, atmospheric absorption and efficiency of the photovoltaic cells. The Linke turbidity factor (Muneer et al., 2004) is used to characterize the clearness of the sky. The lower this factor, the clearer the sky, the larger the beam irradiation and the lower the relative fraction of the diffuse irradiation. For higher altitudes, the absorption is lower because of less radiation scattering by the atmosphere which lowers the Linke turbidity factor. Typical values for the Linke turbidity factor are listed in Table 1.

$T_{LK}$	Sky Condition
1	Pure sky
2	Very clear sky
3	Clear sky
5	Summer with water vapour
7	Polluted urban industrial

Table 1. Typical values for the Linke turbidity factor

The amount of solar energy available per day for propulsion of a solar powered UAV is not only dependant on the clearness of the atmosphere but also highly dependant on the time of the year. UAVs operating during the summer months, when the available energy is at its highest, has approximately 2.2 times the energy available relative to operation during winter months when the available energy is at its lowest. Even when a worst case summer day (with Linke turbidity equal to 5) is compared with a clear winter's day (with Linke turbidity equal to 2), the ratio of available solar energy in summer is still on the order of 1.5 to the available solar energy in winter. This difference in available solar energy is mainly contributed by the distance between the earth and the sun increasing in winter and the smaller sun angle and the shortening in day light hours as a result of the inclination of the

earth axis. When designing solar powered UAVs, consideration has to be given to the expected operating time of the year. Designing for minimum available solar energy conditions may result in an over design by a factor of 2 under maximum available solar energy conditions. An over design factor of 2 has significant negative impact on the UAV airframe design in terms of size and cost. A positive impact may be that the excess solar energy available may be used to overcome the increased aerodynamic drag when the UAV is flying at faster speeds. This may result in UAVs which can be operated at higher flying speeds during the summer months, when the available solar energy is at a maximum. Figure 1 shows the theoretically available energy which can be collected in the southern hemisphere at a latitude of 25 degrees by a photovoltaic array of 1 m<sup>2</sup> with an efficiency of 16% as a function of the time of the year. Another issue to consider is matching the output of the photovoltaic cells to the input of the energy storage medium, which can make a great difference in the efficiency of power utilization, thus some form of maximum power point tracker will be required (Luque & Hegedus, 2003).

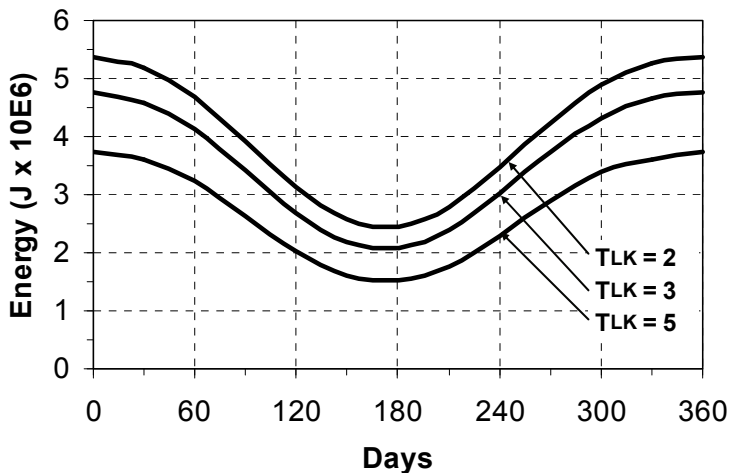

Figure 1. Available solar energy per day which can be collected by a 1 m<sup>2</sup> photovoltaic array with a 16% efficiency for various values of Linke turbidity factor where day 1 corresponds to the summer solstice in the southern hemisphere

### 3.1.1 Solar Energy Advantages

Advantages of using photovoltaic cells as energy sources can be summarized as follows:

- Very little maintenance required;
- Photovoltaic cells are non-polluting; and
- Essentially no operating cost. The greatest cost of photovoltaic cells is the initial acquisition costs.

### 3.1.2 Solar Energy Disadvantages

Disadvantages of photovoltaic cells are the high initial procurement cost and the fact that it can only generate electrical power during daylight hours which necessitates the use of energy

storage mediums. Secondly photovoltaic cell efficiency is rather low in the range of 14% to 18% for commercially available terrestrial grade cells. Space grade cells have efficiencies as high as 24% (Luque & Hegedus, 2003). The dependence on the atmospheric conditions makes solar energy a lot less predictable and seasonal variations will affect the design.

### **3.2 Lithium Polymer Cells**

Lithium polymer cells are constructed using a flexible, foil-type case containing an organic solvent. In lithium-ion cells a rigid case presses the electrodes and the separator onto each other whereas in polymer cells external pressure is not required because the electrode sheets and the separator sheets are laminated onto each other. Lithium polymer batteries, the next generation power source (van Schalkwijk et al., 2002) since no metal battery cell casing is needed, the weight of the battery is reduced and it can be formed to shape. The denser packaging without inter cell spacing and the lack of metal casing increases the energy density of Li-Po batteries to over 20% higher than that of a classical Li-ion batteries. Lithium polymer cells are considered fully charged when the cell terminal voltage reaches 4.2 V and are fully discharged when the cell terminal voltages decreases to a voltage of 3.0 V. (van Schalkwijk et al., 2002). A variety of Li-Po batteries are commercially available consisting of different series and parallel configuration of cells making up the required battery voltage and current characteristics.

#### **3.2.1 Lithium Polymer Cell Advantages**

In UAV applications the obvious benefit of using Li-Po batteries is the higher energy density offered. Advantages of Li-Po batteries can be summarized as follows:

- High energy density;
- Low self-discharge properties;
- The flexible casing of the polymer batteries allow for design freedom in terms of profile thicknesses; and
- Low maintenance.

#### **3.2.2 Lithium Polymer Cell Disadvantages**

Lithium polymer cells have special recharging procedures necessitating the use of specifically designed chargers. Charging Lithium cells is the most hazardous aspect of the batteries. Cell count and terminal voltage are of utmost importance when charging Li-Po batteries. It is important not to exceed both the high voltage limit of 4.2 V and the low voltage limit of 3.0 V. Exceeding these limits can permanently harm the battery and may result in a fire hazard. When series cells configurations are employed to obtain the required battery terminal voltage cell balancing circuits are required to ensure an even voltage distribution over the cell stack. Failure to balance the series cell stack may cause overcharging of individual cells with the associated fire hazards. Lithium polymer batteries are also subject to ageing effects, due to this the expected lifetime of such batteries is limited. Disadvantages of Lithium polymer batteries can be summarized as follows:

- Special charging circuits required to maintain cell voltage within safe limits;
- Subject to aging;
- Subject to cell balancing for series stack configurations;
- High procurement cost; and
- Requires special disposal processes.

### 3.3 Hydrogen Fuel Cells

Polymer electrolyte membrane fuel cells (PEMFC) are constructed using a solid polymer as electrolyte, absorbent electrodes combined with a platinum catalyst. Hydrogen gas is recombined with oxygen gas producing electricity with water vapour as emission. Onboard storage of the hydrogen would be required for UAV applications. Alternatively, hydrogen may be manufactured onboard the UAV from electrolysis of water using solar energy. A closed loop system could be operated whereby the water from of the PEMFC can be electrolyzed into oxygen and hydrogen for later re-use. Oxygen is generally obtained from the surrounding air. Operating temperatures are relatively low around 80 °C, enabling quick starting and reduced wear. Platinum catalysts are required for operation and to reduce corrosion. Polymer electrolyte membrane fuel cells are able to deliver high energy densities at low weight and volume, in comparison to other fuel cells (Barbir, 2005).

#### 3.3.1 Fuel Cell Advantages

The advantages of using PEMFCs can be summarized as follows:

- Relative high efficiency;
- High energy density;
- Low noise;
- Non carbon producing only water emission; and
- Low maintenance.

#### 3.3.2 Fuel Cell Disadvantages

The biggest disadvantages of using PEMFCs are the initial procurement cost and the safety issues regarding the storage of the onboard hydrogen gas. PEMFCs also suffer from a limited lifetime.

### 3.4 Super-Capacitors

Super capacitors, (SC) or Ultra-capacitors are also known as Electric Double Layer Capacitors (EDLC). Super capacitors have a double layer construction consisting of two carbon electrodes immersed in an organic electrolyte. During charging, ions in the electrolyte move towards electrodes of opposite polarity; this is caused by an electric field between the electrodes resulting from the applied voltage. Consequently, two separate charged layers are produced. Even though the capacitors have a similar construction to batteries, their functioning depends on electrostatic action. No chemical action is required; the effect of this is an easily reversible cycle with a lifetime of several hundreds of thousands of cycles (Conway, 1999).

#### 3.4.1 Super-Capacitors Advantages

The advantages of Super capacitor energy sources can be summarized as follows:

- High cell voltages are possible, but there is a trade-off with storage capacity;
- High power density;
- No special charging or voltage detection circuits required;
- Very fast charge and discharge capability; and
- Life cycle of more than 500,000 cycles or 10-12 year life time.

### 3.4.2 Super-Capacitors Disadvantages

Disadvantages of Super capacitors can be summarized as follows:

- Low energy density;
- Low power to weight ratio when compared to current battery technology;
- Moderate initial procurement cost; and
- High self discharge rate.

### 3.5 Electrical Power Source Comparison

When considering an electrical energy source for powering of an UAV the before mentioned advantages and disadvantages must be compared. The key performance parameters for energy sources in UAV applications were identified as:

- Energy density (Wh/kg);
- Energy unit cost (Wh/\$); and
- Lifespan (years).

Figure 2 shows a comparison of the key performance parameters for the energy sources considered.

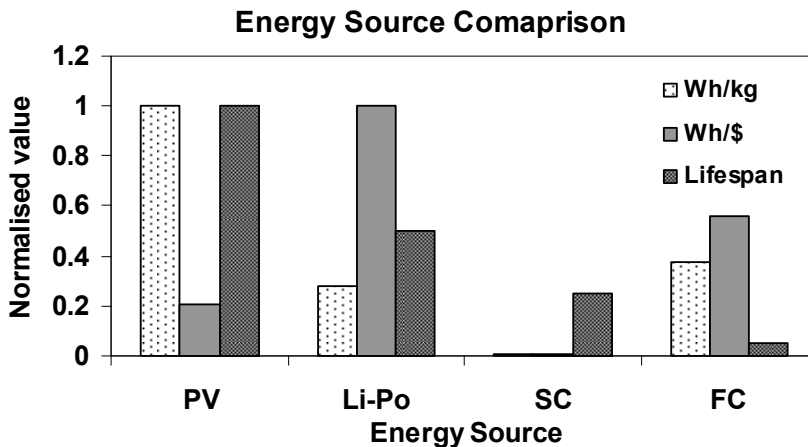

Figure 2. Normalised comparison of the key performance parameters for the energy sources considered

An algorithm was designed which is capable of determining the most applicable selection of the energy source, from the sources considered for a given UAV application. The UAV application is quantified by the user input of the following parameters:

- The electrical power required by the application;
- The maximum allowed weight of the power source;
- The required time duration for the supply of electrical power. This can also be considered as the flight duration; and
- The maximum cost limit for the power supply.

The results from the selection algorithm are presented in Table 2.



Flight Duration (h)	Power Source Weight (kg)	Required Power (W)	Solution 1	Solution 2
2	5	40	PV	Li-Po
10	4	20	Li-Po	FC
12	10	150	FC	PV-Li-Po
21	10	200	PV-Li-Po	None
24	20	200	FC	PV-Li-Po

Table 2. Applicable energy source for various UAV application requirements

From Table 2 follows for longer flight durations and high power ratings the preferred solution is hydrogen fuel cells or a photovoltaic-lithium polymer battery hybrid power supply. For lower power supply weight budgets and relatively short flight time durations the demands are met by using photovoltaic cells or lithium polymer battery supplies. Hybrid solutions are preferred above the fuel cell solution at lower weight requirements due to the photovoltaic cells advantage in power density, but the initial costs exceed that of fuel cells. However considering the life expectancy of the hybrid solutions this option becomes more attractive. A fuel cell solution is and all round good option and the relative simplicity of such a system makes this option very attractive.

From the results presented in Table 2 one of the ideal power solutions for long endurance UAV flights is the hybrid solution between the photovoltaic cells and Li-Po batteries. Considerations for implementation of hybrid photovoltaic cells and Li-Po batteries are presented in the next section.

### 3.6 Considerations for the Implementation of a Hybrid PV-LiPo UAV Power Source

Charging of a Li-Po battery requires the application of a 4.2 V voltage source across each cell in the battery with the current limited to the C rating of the battery. This is referred to as constant voltage, constant current charging. In Li-Po batteries the individual cells are connected in a series configuration in order to achieve the desired battery terminal voltage. The series connecting of cells requires that the cells are all identical in capacity and state of charge. This may not always be true. High discharge rates can cause cell imbalances as does cell aging. Series connection of Li-Po cells in batteries may lead to cell drifting, which poses serious dangers when charging. The proposed solution is therefore to connect all the Li-Po cells in parallel forcing the cells to the same state of charge. There are additional benefits of having the cells in parallel such as:

- Each cell ages the same amount if equal current sharing is implemented significantly reducing the charging safety hazards;
- Increased redundancy when cell stacks are set up so that the remaining sources pick up the slack of a faulty cell; and
- All cells in the stack are forced to same state of charge.

There are however a number of disadvantages to parallel connection of cells in battery stacks which may include the following:

- Cell isolation circuitry may be required to prevent a faulty short circuited cell to discharge the remaining cells; and

- Lower battery terminal voltage which would necessitate the use of boost converters to obtain the required operational voltage.

Charging a Li-Po cell at 1C for 1 hour will ensure that at least 70 % of the rated power will be charged. Considering the graph shown in figure 3, it is observed that the power input into the cell starts to fall off once the voltage of the cell reaches 4.1 V. By paralleling Li-Po cells in an overly large battery stack a battery is created which is able to store all the available energy generated by the photovoltaic cells. Thus it would be best to use a battery stack, consisting of a number of cells connected in parallel, with output voltage regulation using a self adjustable booster circuit. The power rating of the battery should be such that 70 % of the battery power capacity coincides with the maximum total power obtainable from the PV cells for the flight duration. This arrangement not only simplifies the circuit design by eliminating the need for specialised current limiting charging circuits but also ensures that all the available power generated by the photovoltaic cells can be stored without the need for complex switching circuits to switch the excess energy to the remaining batteries.

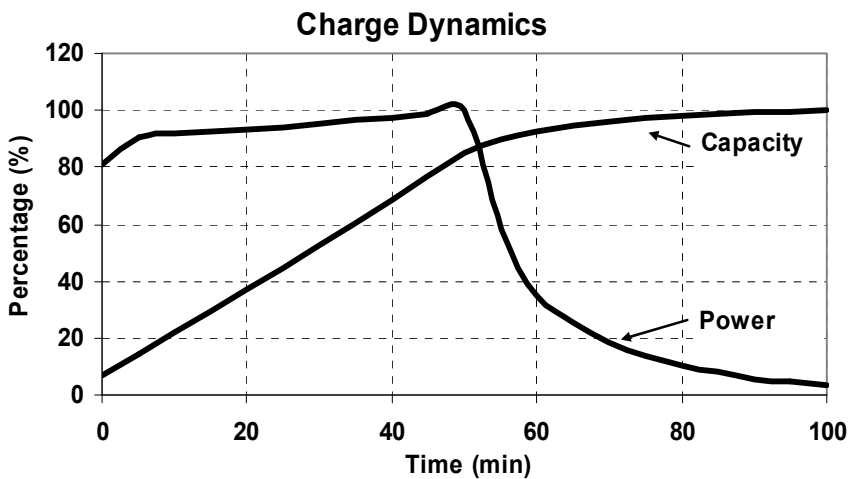

Figure 3. Power input into the battery per unit of time as function of time. The capacity of the battery is indicated as a percentage

In order to evaluate the feasibility of the proposed electrical power source a simulation was performed of the typical power flow during a long duration UAV flight

### 3.7 Long Endurance Solar Powered UAV Flight Simulation

For the evaluation of long endurance low altitude solar flight a simulation model was realized. The simulation model includes a radiation model which is parameterized by the geographical position and the time of the year (Bird & Halstrom, 1981). A facility is provided whereby the flight start time can be entered as an offset to the simulation time. The model of the solar panel takes into account the solar array size and efficiency. The power generated by the solar array is then made available to the battery model. A UAV aircraft model was implemented which computes the required power for level flight.

Electrical power required by the avionics is added to the power required for level flight to obtain the total power requirements for the UAV flight. Figure 4 shows the power progression graph for the power flow of the UAV during a long duration UAV flight of 48 hours. The flight was started at 18:00 in the evening on summer solstice with a fully charged battery.

Better insight into the power balance requirements can be obtained by plotting the energy flow graph of the UAV as in figure 5. It can be seen that the energy collected by the solar array always exceeds the energy used by the UAV.

The contribution of the fully charged battery can be seen as the flight starts at 18:00 in the evening. The initial battery charge is nearly depleted at 06:30 in the following morning from where charging resumes to full capacity at 17:00 in the afternoon. As the available light diminishes towards the evening the battery starts to discharge to supplement the dwindling available solar energy. At about 06:00 in the morning of the second day the battery is again nearly discharged when the following charge cycle begins.

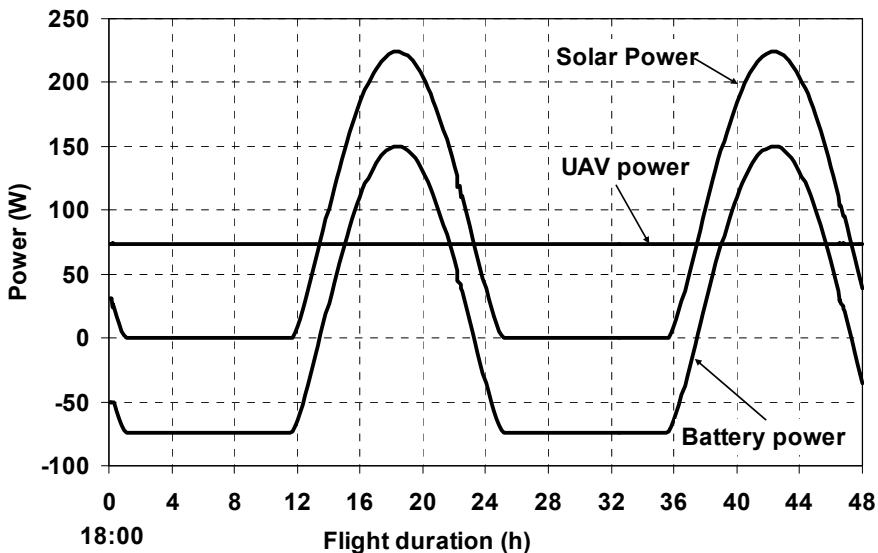

Figure 4. Power flow for a long endurance solar powered UAV requiring 74 W for maintaining level flight. A solar array of 1.2 m<sup>2</sup> with efficiency of 16 % is collecting the solar energy. Negative power means power being supplied by the battery

From the work presented it can be concluded that the primary consideration in the design of a PV-LiPo hybrid power supply for low altitude long endurance UAV is the available solar energy which can be collected by the photovoltaic array mounted on the wing surface of the UAV. The available solar energy is very strongly dependant on the time of year and the clearness of the atmosphere. During operation of long endurance flights the UAV must be trimmed for optimal speed ensuring maximum endurance. The capacity of the energy store can be determined by the power and energy requirements of the UAV. By taking these considerations into account it would be possible to a PV-LiPo hybrid power supply to power a low altitude long endurance UAV capable of demonstrating sustained flight.

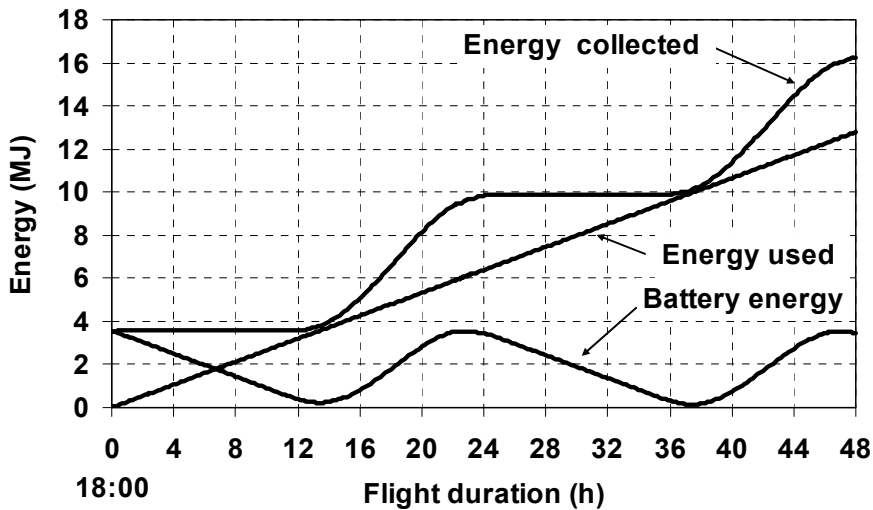

Figure 5. Energy flow for a long endurance solar powered UAV for a flight duration of 48 hours

#### 4. Navigation and Control

Consider the following example of a situation that frequently arises. Let's say company ABC Imaging have expert knowledge in the development of some high-powered thermal imaging sensor and they consider it a profitable business opportunity to integrate the thermal imaging payload with a UAV and sell the complete product with the sensor as an integrated payload. How should they go about the integration of their payload with the UAV as their expertise is in the field of thermal imaging sensors and not autonomous aircraft? It is suggested that this company follow one of the following three options:

1. Recruit a whole team of engineers with UAV knowledge and build their own system, including the airframe and all the subsystems, from scratch - usually resulting in excessive cost and delays in getting the integrated product into the market;
2. Acquire some of the key components such as the airframe, the control system, communication links, etc. as building blocks and integrate these with their imager to obtain the UAV system. This could mean that some of the minor components needed for the cooperation and management of the various subsystems be developed; or
3. Obtain an off-the-shelf fully functional UAV as an aerial platform and integrate their imager as payload with this platform.

It should be clear that each one of the options have its advantages and disadvantages. Option 1 is a high risk alternative that should probably be taken if the company is eager to establish a long-term presence in the UAV field and expand their technical capability beyond their current field of expertise. Options 2 and 3 usually results in lower risk and lower product-into-market delays, with Option 3 probably resulting in the shortest development time with the least amount of flexibility.

The perspective that will be presented in this section does not necessarily present one of the options as superior to any of the others. The choice of the developmental strategy is a business decision that needs to be evaluated on the merit of the position of the business. It is, however, suggested that small companies with focused payload expertise should generally follow Option 3, somewhat larger companies or ones that have a broader base of technical knowledge could opt for Option 2 with the large companies with an established engineering presence usually deciding on Option 1 or a combination of Option 1 and 2.

The objective of this section is therefore to provide an overview of the autopilot development process and address key technologies that are represented in this process. It will be assumed that the reader does not necessarily have a background in navigation and control. A conceptual overview of some of the key technologies will therefore be presented as part of the content of this section. As the focus of this chapter is on the design considerations of a UAV and not necessarily on the research aspect of control and navigation, predominantly mature, proven techniques of control and navigation are presented. Emphasis will therefore be placed on the design constraints without going into too much of the supporting theory.

As the focus of this chapter is on long endurance UAVs, which is generally considered to be fixed-wing aircraft, the rest of this section will discuss building blocks that can be used in the development of such systems. Apart from complete UAVs and commercially available autopilots, most of the other building blocks are generic enough to be used on different UAV configurations such as airships or rotorcraft.

(Valavanis, 2007) presents a good overview of the development of autonomous helicopter and quadrotor UAV systems. Also included in this book are a variety of subjects on the supporting operations and subsystems needed to develop a successful UAV system. This reference is considered as a good reference for both the inexperienced as well as the established UAV systems engineer who need to gain insight into all the components and subsystems that are needed in modern UAVs.

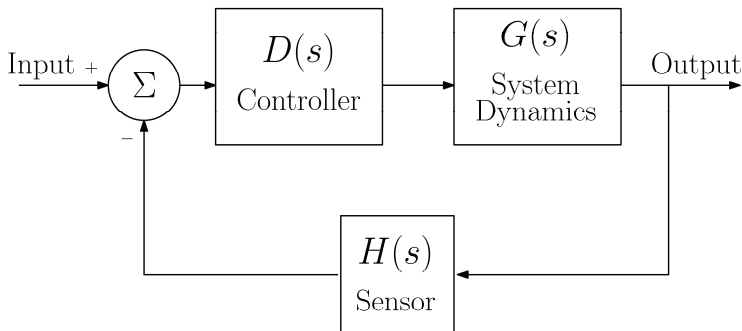

Figure 6. Generic control system block diagram

#### 4.1 Navigation Systems

This section will consider the navigation and control (N&C) system components and subsystems by first looking at the algorithmic aspects involved in the development of the N&C system and then looking at the hardware on which the algorithms can be implemented and that is required to perform the various tasks. The actuator, although being

modelled as part of the controller, will be considered as being part of the airframe and will therefore not be discussed any further. An overview of a generic control system is presented in figure 6. From this block diagram it can be seen that the core building blocks of any control system are the

- Dynamics model of the system – known as the plant;
- The sensor that measures the variables of interest; and
- The actual control algorithm as implemented on the control processor. The actuator is not indicated on the diagram, but is considered to be part of the controller.

#### 4.1.1 Navigation

The sensor system of an aircraft is generally called the navigation system. This system constitutes one of the most critical components on any aircraft and it is of even greater importance on a UAV where there is no pilot onboard that can use his own senses to act as a backup “navigation system”. Due to the criticality of the navigation system, it usually consists of a combination of sensors that are complementary in nature. From an intuitive perspective it should be apparent that the variables of interest for autonomous UAV control are the aircraft

- Altitude;
- Position;
- Velocity;
- Acceleration; and
- Orientation (attitude).

The selection of sensors is therefore supplementary in nature to ensure that a trustworthy set of the most critical parameters are available at all times. Apart from the availability of the critical system parameters, it is also necessary to perform some calculations on these parameters and combine the various measurements to provide the optimal set of system variables at all times.

The next two subsection present a discussion of the fundamental algorithms involved with navigation and then discuss the process of combining the measurements from various sensors into an optimal measurement.

##### 4.1.1.1 Navigation Algorithm

The core element of aircraft navigation systems is the inertial navigation system (INS). The INS consists of a sensor block called the Inertial Measurement Unit (IMU) and the navigation processor used to implement the navigational equations. (Titterton and Weston, 2004) present a comprehensive discussion on the various inertial sensors as well as the navigational equations necessary for successful INS development.

The IMU consists of a triad of 3 orthogonal gyroscopes and a triad of 3 orthogonal accelerometers. Most modern navigation systems make use of strapdown navigation where the IMU is fixed to the body of the aircraft. The gyroscopes therefore measure the angular rotational rate of the aircraft body in the body  $(x,y,z)$  coordinate system (also known as the body frame) relative to inertial space. The accelerometers measure the aircraft acceleration in the body frame in terms of the body  $x,y$  and  $z$  components.

The advantage of classical inertial navigation is a self-contained system that does not require any external measurements to operate and the navigation sensors are therefore not susceptible to external sources of interference.

The navigational equations that are applied to the IMU output to obtain the complete set of navigation parameters is presented in block diagram form in Figure 7. It consists of the double integration of the measured acceleration to obtain the aircraft velocity and then the position. In a strapdown navigation implementation the acceleration is measured in the aircraft body axis and the position of the system is required in a local level coordinate system called the navigation frame. To determine the aircraft acceleration in the navigation frame, it is necessary to determine the orientation of the aircraft body frame relative to this navigation frame and use this description of the relative orientation between the two axis systems to convert the acceleration measurement from the body frame to the navigation frame. This is where the gyroscopes come into play. As presented in figure 7, the gyro cluster measurement of the aircraft angular rate relative to the inertial frame is integrated to determine the system's orientation (known as the attitude). The attitude can be presented in terms of Euler angles (roll, pitch and yaw), in terms of a direction cosine matrix or in terms of a quaternion representation (Titterton & Weston, 2004; Stevens & Lewis, 2003; Farrell, 2008; Rogers 2007; Groves, 2008; Farrell & Bath, 1999). The attitude representation is used to convert the accelerations to the navigational frame. Some additional corrections for the effect of the Earth's rotational rate on the gyros, changes in gravity as a function of position and altitude and the Coriolis effect resulting from the relative rotation between the two frames is also needed as presented in Figure 7.

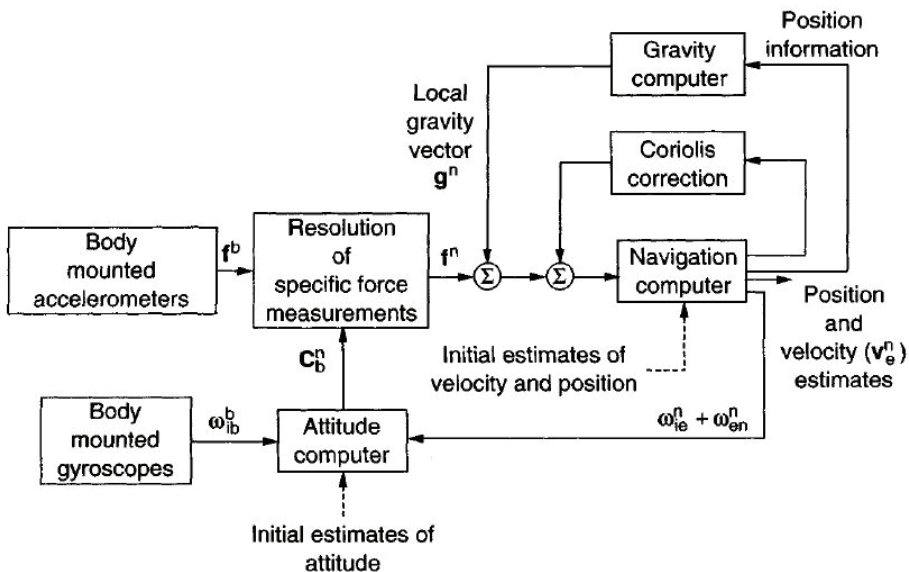

Figure 7. Inertial navigation system algorithm block diagram. Taken from Titterton & Weston (2004)

The navigation equations presented in Figure 7 is collectively known as the INS. The output of INS consists of the complete system position, velocity, acceleration, orientation and angular rates of rotation. These parameters are used by the control system as the measurements of the system motion on which the control action will be performed.

In some situations the complete navigational solution is not required and only the aircraft orientation and heading is required by the control system. A standalone GPS unit is then used for position information. Such a unit is called an attitude and heading reference unit (AHRS). The AHRS consist of a simplification of the INS equations presented in Figure 7 by not performing the computations to determine the aircraft position and velocity.

Pure inertial navigation solutions have the advantage of being immune to interference as it does not depend on data received from external sensors. To be usable in an independent configuration, it is necessary to use reasonably high quality sensors. The reason being both gyros and accelerometers are subject to significant sensor measurement noise and the noise directly impacts the navigation solution. Any errors in the accelerometers are integrated twice and any gyro errors are effectively integrated three times during the calculation of the aircraft position. The result is that even a small error in any of the sensors cause the navigational solution to rapidly deteriorate.

IMUs used to perform pure inertial navigation portray very low levels of sensors noise. These very high quality inertial sensors (known as inertial grade IMUs) are very expensive, typically costing in the range of millions of US-dollars and can generally be used to navigate autonomously for periods of time ranging from a couple of hours up to a number of days and even longer depending of the quality of the sensor. Lower quality inertial sensors used to navigate autonomously for about an hour are called sub-inertial grade sensors while the lowest quality sensors are called tactical grade sensors. Sub-inertial grade sensors are generally about an order cheaper than the inertial grade sensors, but are still about an order more expensive than the tactical grade sensors. The problem with tactical grade sensors are, although relatively cheap, they cannot be used as the primary sensors for navigation for any period longer than a couple of minutes before the accumulation of errors start to dominate the navigational solution.

#### **4.1.1.2 Hybrid navigation**

The accumulation of errors in pure inertial navigation system and the high cost associated with inertial grade sensors have resulted in the practise of aiding the navigational solution with other sensors. Probably the most widely used navigational aide is the Global Positioning System (GPS), which provides high accuracy position and velocity measurements with bounded errors which can be used to improve the pure inertial navigational solution when combined with the output of an INS (Steven & Lewis, 2003; Farrell, 2008; Rogers, 2007; Groves, 2008; Farrell & Bath, 1999). GPS and INS measurements are combined in an optimal way using an estimation algorithm known as the Kalman filter.

Various configurations for the combination of the data exist, but the actual functionality of the Kalman filter does not differ much. The Kalman filter is a statistical estimator using the noise properties of the various sensors to determine the weighting factors when combining the measurements. References on the applications of Kalman filters to inertial navigation are found in (Steven & Lewis, 2003; Farrell 2008; Rogers, 2007; Groves, 2008; Farrell & Bath, 1999; Maybeck, 1994). A more detailed discussion on Kalman filtering and optimal estimation is presented in (Maybeck, 1994; Simon, 2006; Zarchan & Musoff, 2005; Lewis et al, 2008). A typical use of the Kalman filter in navigation aiding is the complementary filtering scheme (Bar-Shalom & Li; 2001) as presented in Figure 8.



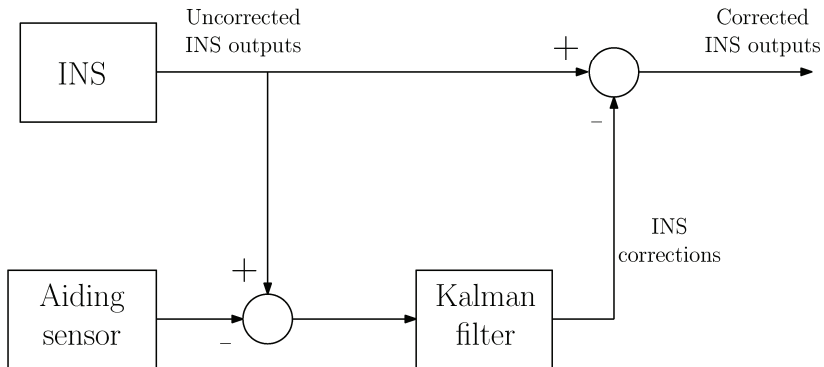

Figure 8. Complementary filtering as used for INS aiding

One of the disadvantages of GPS that became clear in recent years during the Afghanistan and Iraq wars is it can be jammed, either from specifically designed jamming equipment or by accident by transmitters operating in the GPS frequency band. This has motivated significant research into the use of alternative sensors for navigation aiding. The use of optical sensors as vision-based navigation aids is receiving much attention due to the sensor being independent of external transmitters like GPS. The advent of high-powered image processing hardware is contributing to the increased momentum of this method of aiding. Imaging sensors are used as aiding sensors in the following configurations:

- Optical altimeter, where two or more cameras are used to develop an altimeter through stereo vision;
- Feature detection in Simultaneous Localization and Mapping (SLAM), where the image is processed to determine the location of features in the scenes and these features are either correlated with known locations of features or used to develop a map used to update the navigational information;
- Range sensor through stereo vision, where the sensor is not purely used as an altimeter, but where distance to identified features in the image is determined from the combination of multiple images; and
- Angular rate sensor, where the system's angular rate can be determined using optical flow techniques.

Apart from GPS and optical sensors, other sensors frequently used in navigational aiding on UAVs are:

- Magnetometer, utilising the Earth's magnetic field to determine orientation and sometimes position information;
- Barometric sensors, using air pressure to determine the aircraft altitude;
- Laser altimeters, providing very high accuracy altitude measurements; and
- Radar, a ground-based sensor predominantly under military control but sometimes available for civilian use.

#### 4.1.2 Calibration and alignment

Two critical tasks associated with inertial navigation that can severely influence the navigation accuracy are the calibration and alignment of the INS. Calibration is the process whereby the errors associated with the IMU are determined and stored in software for use in an online compensation routine. IMU calibration is an extremely specialized area that requires expensive test equipment. This is an area that should be ventured into with great care and it is therefore suggested that pre-calibrated inertial sensors be used whenever possible. By following this approach the inner technical workings of the IMU is hidden from the application engineer who simply want to use the sensor as a black-box measurement device.

Alignment is the process whereby the initial position and orientation of the IMU is determined to act as initial conditions for the INS integration equations. Traditionally, strapdown inertial systems depended on gyrocompass alignment (also known as static alignment or ground alignment) of the system as described by (Britting, 1971). In this method the accelerometers are used to determine the initial estimate of tilt (roll and pitch) angles of the aircraft through a process known as analytical alignment. Once the tilt angles are known, the rotational speed of the Earth is measured by the gyros to determine the heading of the IMU. The initial alignment results are refined using a Kalman filter while the heading converges to the actual value. The whole process usually takes about 10 to 15 minutes. Position is either determined by positioning the aircraft at a known position on the runway, or from a high accuracy GPS position measurement. Disadvantages of this approach to alignment is that the gyros need to be quite accurate (at least in the high end of the sub-inertial grade sensors) to detect the rotational rate of the Earth performing the heading alignment. In fact, the need for accurate heading alignment is the biggest driving factor when specifying accuracy of the gyros in the IMU. If alternative alignment techniques are used, gyro requirements can be significantly reduced, thereby reducing the total IMU cost. (Farrell, 2008) presents some alternatives for alignment with the use of a magnetometer to determine the heading angle being the most widely used method for low-grade IMUs which is not sensitive enough to detect that Earth's rate of rotation.

#### 4.1.3 Design Considerations: Long Endurance Navigation

From the discussion on navigation presented in the previous sections, the following design considerations can be highlighted for long endurance missions:

- Proper calibration of the navigation sensors and high accuracy alignment before the start of the mission are of utmost importance to ensure good navigation data for long endurance missions.
- Low grade inertial sensors cannot be used to perform autonomous navigation without being aided by an additional sensor. GPS is the logical choice for aiding the low grade IMUs by means of Kalman filter mechanization.
- A high accuracy reliable GPS receiver is essential if lower accuracy inertial sensors are used.
- Although not discussed here, the navigation computations and the method and sequence in which these computations are performed on the navigation computer is very important as any delays in data resulting in skewing or stale data could be catastrophic to the system performance.

## 4.2 Aircraft Control Systems

The International Aerial Robotics Competition<sup>1</sup> (IARC) has been playing a significant role in accelerating the development of UAVs and specifically in the advancement of the control strategies. Initially when the competition started in 1991, the focus was strongly on the development of the control algorithms, but since then the control systems technology has matured to such a degree that the control system is usually regarded as a “hidden technology” with more focus being placed on the development of the payload sensors, sensor intelligence, autonomous mission planning and collaboration between multiple vehicle systems. The control system developments occurred as part of the IARC have had a significant impact on the control systems of commercial products as many of the algorithms developed have matured into usable products.

A vast array of control algorithms exist that have been implemented with varying degrees of success. In general these control strategies can be divided into the areas of classical, modern and state-space control as presented in the following three subsections.

### 4.2.1 Classical Control

The term classical control refers to the oldest and most established method of control. A number of techniques fall in this category which consists of a control loop being designed per controlled variable, resulting in a large number of independently designed control loops for large multi-variable systems.

The classical approach to fixed-wing UAV control can be divided into a number of actions, being:

- Attitude stabilization;
- Longitudinal control; and
- Lateral control.

Controllers are applied to perform each one of these actions by means of multiple control loops. The attitude stabilization loop is usually the innermost loop with the highest control bandwidth. The lateral and longitudinal control loops require lower bandwidth actions and these are closed around the attitude loop to control the aircraft altitude, velocity, position and heading. Figure 9 and figure 10 present the classical autopilot multi-loop configurations for the longitudinal (altitude hold) and lateral (heading hold) modes, respectively. In both these systems, the innermost loops stabilize the aircraft rates ( $q$  is the pitch rate and  $p$  is the roll rate), followed by the aircraft orientation ( $\theta$  is the pitch angle and  $\phi$  the roll angle). The outermost loops control the true parameters of interest, being the altitude in the longitudinal mode and the heading in the lateral mode.

---

<sup>1</sup> <http://iarc.angel-strike.com/> ;

[http://en.wikipedia.org/wiki/International\\_Aerial\\_Robotics\\_Competition](http://en.wikipedia.org/wiki/International_Aerial_Robotics_Competition)

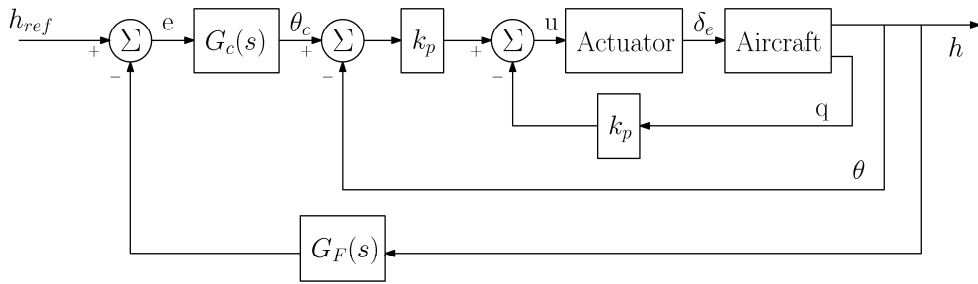

Figure 9. Classical altitude hold autopilot system

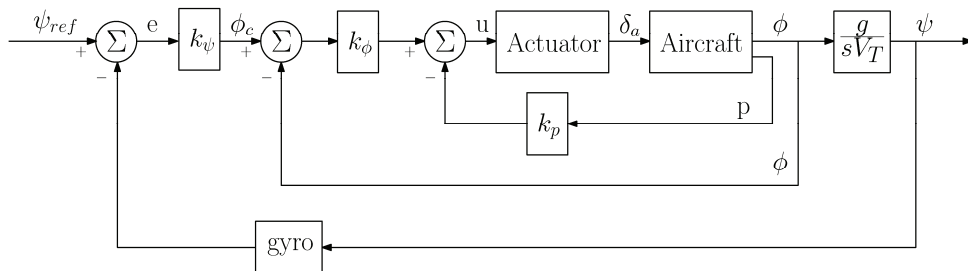

Figure 10. Classical heading hold autopilot system

Probably the most prevalent control strategy amongst all areas of closed-loop control is the proportional-plus-integral-plus-derivative (PID) type of controllers for which the block diagram is presented in Figure 11. The controller consists of three terms that can be combined or left out as required. The advantage of PID control and the reason that this technique is so widely used is the fact that the P (proportional), I (integral) and D (derivative) terms can be very effectively “tuned” in a very short time to obtain a controller that will perform an adequate control action. The “tuning” of the controller can be performed without a dynamics model of the system or without any knowledge of the dynamics of the system. More formal methods could also be used to determine the controller parameters, but the experience-based tuning of the controller terms based on some heuristic rules is most commonly followed.

These heuristic rules can be defined as follows<sup>2</sup>:

- The proportional term  $K_P$  is used to reduce the system rise time and to reduce the steady state error of the system, but it cannot be used to completely eliminate the error. Used on its own, it is the simplest possible controller and often results in an adequate system response.
- The integral term  $K_I$  is used to eliminate the steady-state error, but the expense of dramatically slowing down the system response and possibly even making the system unstable.

<sup>2</sup> <http://www.engin.umich.edu/group/ctm/PID/PID.html>

- The derivative term  $K_D$  has a stabilizing effect on the system response by decreasing the settling time and the overshoot of the system. It does not have any significant impact on the steady-state error.

These guidelines are generally correct, but deviations from them can be experienced when any of the three parameters is changed, thereby influencing the balance between the three terms. After some trial and error, a general method for tuning the PID terms can be determined. A guideline often followed, is to tune the proportional term until satisfied, then add integral control and finally add the derivative control as necessary.

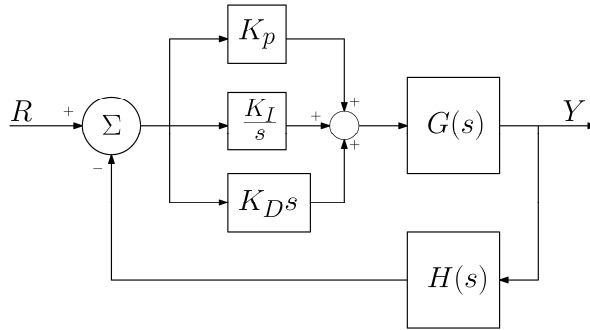

Figure 11. A PID controller

Another classical technique is the lead-lag type of controller which is more of a purist approach to PID control with more options during the control approach. Lead-lag controllers are usually designed using formal design methods such as the frequency domain techniques (using Bode plots) or the root locus method. These techniques are based on a proper dynamics model of the system.

The book of (Franklin et. al., 2006) is an excellent introductory source of information and tools on the design of classical and state space control systems. (Stevens & Lewis, 2003; Roskam, 1979; McRuer et. Al, 1973; Blakelock, 1991) present a detailed discussion of various aspects of aircraft control from the classical perspective.

#### 4.2.1.1 Dynamics model

The use of the proportional-plus-integral-plus-derivative (PID) control strategy on low-cost UAV systems in recent years has resulted in less emphasis being placed on the development of a dynamics model for the aircraft as an adequate controller can be obtained through the tuning of the controller parameters. However, most methods of control system design depend heavily on the availability of an accurate dynamics model of the aircraft. A high fidelity deterministic flight controller cannot be obtained without using such a model. A detailed treatise on dynamic and aerodynamic modelling of aircraft is beyond the scope of this chapter. It is a fairly complex field combining knowledge from a number of disciplines to derive the model to be used in the development of the control system and in a computer simulation to test the control system. (Stevens and Lewis, 2003) presents a thorough discussion on the development of the complete dynamic and aerodynamic model needed for the design of a fixed wing autopilot. (Roskam, 1979) looks in more detail at the methods used to obtain the stability derivatives used to describe aerodynamic forces and moments on

the aircraft. It must be emphasized that a proper grasp of the fields of aircraft modelling and simulation are needed to design trustworthy aircraft autopilot systems.

#### 4.2.2 Modern Control

Since the 1960's the development of larger, more complex systems have necessitated that the methods of control design be updated to accommodate these systems. The state-space approach to control system design (generally known as modern control in comparison to the traditional methods that was known as classical control) was developed to address this issue. A number of design techniques based on the state-space approach is in operation on practical systems.

The non-linear nature of the full aircraft dynamics model means that either the high complexity non-linear design techniques will need to be followed, or that a linear approximation to the non-linear model be determined. The last option is usually taken where a number of linear system models are identified by linearizing the non-linear model at a couple of operating points that represent the actual operational conditions of the aircraft. A separate set of controller gains is determined for each operating point with a different controller being selected based on the operational conditions - a process known as gain scheduling.

The LQR techniques (Sinha, 2007; Skogestad & Postlethwaite, 2005; Stevens & Lewis, 2003) is one technique that are used as part of such a gain scheduling strategy. It requires that a relative high accuracy system model be available for the control system design. Based on the noise properties of the system model and the measurements, optimal feedback control gains are determined that will result in the fastest possible system response while limiting the required control effort needed to achieve this performance. Stevens & Lewis, 2003 presents a detailed discussion of the application of this technique to the design of aircraft control systems where the complexity of the systems and the number of parameters that need to be tuned require modifications to the standard LQR techniques.

For some implementations uncertainty exists in the system model or in the operational environment in which the controller will be used. Under these conditions robust control design techniques are used. The most widely used robust control techniques are the linear quadratic regulator / loop-transfer recovery (LQR/LTR) and the H-Infinity (H-inf or  $H_\infty$ ) techniques. Sinha, 2007; Skogestad & Postlethwaite, 2005; and Stevens & Lewis, 2003 discuss these techniques from both theoretical and practical perspectives. The H-Infinity ((H-inf or  $H_\infty$ )) design technique is a robust frequency-domain method of designing controllers for systems that exhibit uncertainty either in terms of the system model used to design the controller, or in terms of the operational environment. The LQR/LTR approach is based on the separation of the controller design into a Kalman filter observer and then a state feedback controller. The advantage of this approach, which is very popular amongst aircraft designers, is that the state feedback controller (the linear quadratic regulator) has some inherent properties that result in a robust controller which is aided with the LTR technique. Stevens & Lewis, 2003 discusses the application of this technique to the autopilot design of fixed-wing aircraft.

#### 4.2.4 Control system hardware

On most UAVs the type of onboard systems and sensors are constrained in terms of:

- Size;

- Weight; and
- Electrical power requirements.

Given the total system cost an important driving factor on most UAVs, the selection of the actual avionics and sensor hardware are of critical importance. This section will attempt to address some of the available options in terms of computer hardware and sensors available for navigation use on a fixed-wing UAVs. An invaluable source of information is the UAS-Info website<sup>3</sup> containing the annual publication of the UVS-International Yearbook. Apart from articles of general interest, the yearbooks contain sorted lists of available IMUs, autopilots, complete UAV systems, payload sensors, power plants and much more.

#### 4.2.4.1 Inertial Sensors

In general the accuracy of an aircraft inertial sensors is directly proportional to the cost of the sensors. The number of manufacturers of both inertial and other sensors are so vast that a discussion is beyond the scope of this chapter. References for available sensors and subsystems are the Reference Section of the UVS-International Yearbook<sup>4</sup> under the heading Autopilots & Inertial Measuring Units and the Association for Unmanned Vehicle Systems International (AUVSI) website<sup>5</sup> and their monthly magazine Unmanned Systems.

The inertial sensor pack is probably the most critical aspect governing the total UAV navigational and positioning performance. It will also be the most expensive component on the UAV, only to be surpassed by very high quality integrated electro-optical sensor systems. The normal design constraints of weight, power and size play slightly less of a role when it comes to the inertial sensors as some accommodation will be made to be able to host the sensor which guarantees mission success. Important factors to consider when buying the inertial sensors are listed below:

- Is the IMU pre-calibrated?;
- Is the sensor-pack accurate enough to allow for gyro-compass alignment? If not, an additional magnetometer or a sensor of equivalent performance including a magnetometer will be required.
- Does the sensor pack have sufficient dynamic range for the type of application?
- Is the environmental specification of the sensor pack compatible with the operational domain of the aircraft? Aspects to consider are shock and vibration, temperature, moisture and operational range in terms of height above sea level.
- Does the system have adequate interface connectors for the type of application? Some requirements could be moisture proof, dustproof or vibration proof connectors.
- Is the data-rate of the sensor output compatible with the requirements of the control system?
- Is the sensor data time-tagged or is the data-latency such that it can be ignored in the system design? Delays in inertial measurements which cannot be precisely characterised results in degraded system performance.

There are four types of inertial sensors available and listed in order of reducing cost are ring laser gyros, mechanical gyros, fibre-optic gyros and MEMS (Micro-Machined ElectroMechanical Systems). Due to the high accuracy inertial sensors being an enabling

---

<sup>3</sup> <http://www.uvs-info.com>

<sup>4</sup> <http://www.uvs-info.com>

<sup>5</sup> <http://www.auvsi.org>

technology for the development of UAVs and for guided weapons alike, high accuracy inertial sensors are governed by ITAR (International Trading in Arms Regulations). The result is a significant amount of time and effort usually have to be spent to obtain the necessary export permits and end-user certificates before the systems are received from the manufacturer. Fortunately the combination of GPS with a low-cost INS usually results in a system of sufficient accuracy. Once again, the combination of these two sensors may also be subject to ITAR, leaving the end-user no other option than buying a low-cost IMU or AHRS, convert this into an INS, and then removing the inaccuracies in the system through the combination with GPS or other sensors.

For the other sensors acting as aiding sensors in the system, the same type of design considerations as for the inertial sensors can be used, with the most emphasis probably being placed on:

- Interface connector integrity;
- Data interface protocol and data latency;
- Sensor accuracy;
- Weight, power and size; and
- Environmental robustness.

#### 4.2.4.2 Control Processor

One of the design considerations for a UAV is whether the complete system will be designed or whether mature building blocks will be used to develop the system. When the hardware for the flight management and flight control system is considered, the “buy” or “develop” issue plays a very important role. Designing an in-house processor board for the control and navigation system does have the advantage of tight coupling between the processor and the various sensor systems, potential low power requirements, low weight and custom form factors, but such custom-built hardware could easily result in immature hardware. Combine the immature hardware with control and navigation algorithms that are itself still under development and the result could be the system responsible for the safe execution of a mission actually putting the mission in danger. It suggested, unless the weight, power (both computational and electrical) and physical size requirements absolutely necessitates it, the decision should rather be made to buy mature hardware and implement the (perhaps immature) algorithms on it.

A number of different hardware products are available for use as onboard processing systems on the UAV. The most widely used and most mature commercially available hardware platform is probably the PC/104 architecture single board computers (SBCs). An example of a flight computer based on the PC/104 architecture developed at the University of Stellenbosch in South Africa<sup>6</sup> is presented in figure 12. One of the primary advantages of the PC/104 architecture is it has a standard form factor. The PC/104 bus (or extensions thereof in the form of the PC/104+ or PCI/104 busses) forms the main communications backbone enabling various cards with the same form factor, but different functionality, to be stacked together building a more compact computer system with higher functional capability than what could have been fitted onto a single card. The stacking of the various PC/104 form factor cards can be seen in Figure 12. The three larger cards shown in the image are PC/104 cards.

---

<sup>6</sup> <http://esl.ee.sun.ac.za/>



Some of the PC/104 cards available include:

- The main processor board;
- Power supply boards;
- Analog to digital converter cards that usually include digital to analog converters with some digital input/output pins as well;
- Counter / timers cards;
- Direct servo controller cards used to directly power the control system actuators;
- Serial port expansion cards;
- CAN controller cards; and
- Wireless communication and GPS cards.

A huge number of possible manufacturers and distributors of PC/104 based hardware exist worldwide. It is suggested that a local agent with a good track record as a trustworthy supplier of a well-known international brand be used to supply the hardware.

Another topic of great importance when deciding on the hardware to be used, is the operating system used onboard the flight control or navigation computer. If dedicated hardware is designed, the algorithms are usually implemented using assembly language or the C programming language. This approach has the advantage of direct control over the algorithm sequence of execution, but, as was previously said, it could be at the cost of immature hardware.

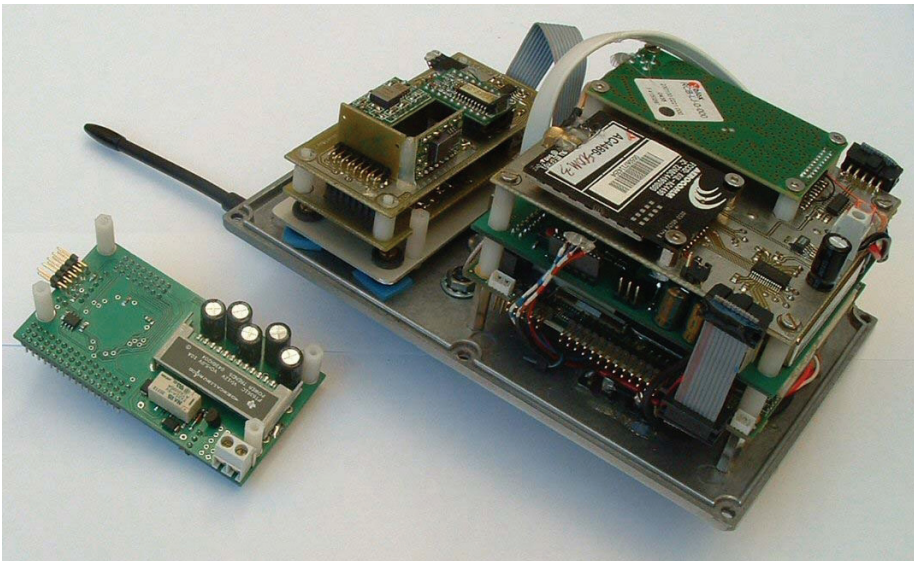

Figure 12. PC/104 based flight computer developed at the University of Stellenbosch, South Africa<sup>7</sup>

Most hardware vendors provide a version of embedded real-time Linux customized to work on their respective hardware platforms. The use of a high-level operating system poses significant advantages, especially when interfacing to complex navigational sensor

---

<sup>7</sup> <http://esl.ee.sun.ac.za/>

systems. The availability of a realtime operating system is a serious consideration when the decision for the flight computer hardware is made. Independent realtime operating systems such as QNX, VxWorks and Winriver Linux do exist, but these are usually expensive and it is not guaranteed for the software to work with all embedded hardware.

(Valavanis, 2007) presents a discussion on the development of an embedded processing system for a UAV based on commercially available hardware. Although not addressed here, the packaging of such a processing system is very important to ensure that the system will continue to operate under all environmental conditions.

## 4.2.5 Commercial Solutions

### 4.2.5.1 Autopilots

For the company that is more interested in the mission and the gathering of the payload data than in the actual development of the control and navigation system, it is an option to consider one of the following commercial-off-the-shelf (COTS) autopilot systems. An almost exhaustive list of available UAV autopilots is published in the reference section of the UVS-International Yearbook<sup>8</sup>. The available systems vary in maturity and reliability of the algorithms and the hardware with fixed wing autopilots generally being more mature than the helicopter autopilots of the same companies.

Some autopilot manufacturers embed the inertial sensors within the autopilot system, thereby eliminating the need for an additional, external sensor system. Although the inertial sensors of the integrated autopilot solutions is not necessarily the highest grade of sensors, the tight integration scheme between the autopilot and the sensor system result in adequate performance. Most high quality commercial autopilots do provide the capability to integrate external inertial sensors with the autopilot. The ability of the system to handle external inertial sensors should be an important design consideration if the accuracy gained from this approach is crucial to the system performance. External inertial sensors often integrated with the autopilot include high accuracy differential GPS systems, laser altimeters or laser scanners, optical sensor information or various onboard or ground-based radar measurement sensors. The inertial sensor integration cost could be excessive and should be addressed during the negotiation and budgeting phases.

As would be expected, most commercial solutions are the products from companies in the USA. This fact has the added disadvantage of the product potentially being subject to ITAR which could make it very difficult for some companies and countries of gaining access to the technology. Not all USA based autopilots are ITAR regulated and fortunately a number of high quality autopilot systems are developed by non-USA companies which are generally available for commercial UAV applications.

Some of the more well-known and commonly used autopilot systems for fixed-wing UAV aircraft are:

- Micropilot - Canada
- weControl - Switzerland
- UAV Navigation - Spain
- Cloudcap - USA
- Microbotics - USA

---

<sup>8</sup> <http://www.uvs-info.com>

- Mavionics - Germany

These systems are relatively mature and present a significant variation in cost and performance. The following aspects should be considered during the selection of a commercial of the shelf (COTS) autopilot:

- Weight and size of the hardware;
- Power requirements;
- The system's ability to handle vibration, shock and the excessive temperatures. Very high temperatures are sometimes experienced inside the UAV avionics bay on the runway, followed by very low temperatures a few minutes later at high altitudes;
- Control algorithm used and the accuracy thereof both in terms of positioning and aircraft stabilization;
- The method of aircraft characterization and autopilot adaptation to the airframe;
- Autonomous "return to home" functionality in case of lost of communication with the ground station;
- The availability of a compatible ground control station (GCS) for the autopilot and whether the system includes the necessary communication data link to connect the autopilot with the GCS; and
- The range of altitudes under which the system can operate.

The system's reliability can be determined from available operational data, if available. It is important to look at the following aspects:

- Number of operational units;
- Total amount of flight hours gained by these units;
- Mean time between failures under normal operational conditions; and
- Number of crashes during operational use.

When the long endurance flight requirement is considered the following concepts should receive attention:

- Absolute sensor accuracy and the drift in the total navigation solution are important to consider.
- Temperature and cooling requirements could play a significant role during long flights as the exposure of a system to high temperatures for long periods of time usually leads to component failure.
- The aggressiveness of the autopilot control strategy. A very aggressive control strategy could result in reduced UAV fuel efficiency resulting in reduced duration of the mission.

It is important to note the purchase of a COTS autopilot system should always be combined with some kind of support contract. Contracts usually last for a period of one year from date of purchase, but some companies provide support for the lifetime of the product. Along with the contract it is important to negotiate the terms and conditions associated with the customization of the autopilot to the airframe. The autopilot setup is usually performed by the manufacturer or their agent and the cost associated with the setup alone could be up to 50% of the actual autopilot cost, excluding travel and accommodation fees. It is therefore advised that the complete product lifecycle cost be considered before a final system is selected. The aspects needed to be considered and budgeted for are:

- Actual system hardware cost;
- System maintenance (repair) fees;
- Annual licensing fees (if applicable);

- Cost associated with customization of the standard system, such as DGPS integration or specific data capturing requirements;
  - Installation and setup fees; and
  - Travel and accommodation cost for the engineers performing the installation and setup.
- It is recommended that a team of technicians or engineers be allocated to take part in the setup process and a technology transfer arrangement be made with the autopilot supplier to train the team for any installations of future systems. The team must also be capable of performing all the maintenance and support on the system, thereby reducing the cost of such exercises. In addition to these comments, it should also be noted most companies are open to negotiations on the unit price if multiple units are purchased. Academic pricing structures are also usually available if the product is used for research applications.

#### 4.2.5.2 Complete UAV solutions

Once the scope of the project and the level of technical depth the company is willing to pursue as part of the UAV development have been determined, it is sometimes found to be the most logical and cost effective option to buy the complete UAV system and integrate the locally developed payload with the airframe. The complete system would consist of the airframe, communication, control and navigation and the power supply and would provide the capability to simply integrate the scientific or commercial payload with the UAV.

An example of such an approach that proved to be very successful is the Maldives AUAV Campaign<sup>9</sup> performed by the Scripps Institute of Oceanography in the USA. In this experiment a scientific payload developed by Scripps was integrated with a Manta UAV<sup>10</sup> to determine the concentration of aerosols in the various atmospheric layers above the Maldives Islands. The objective was to perform the scientific expedition without having to perform a technical venture into the unknown field of UAVs, resulting in the buy and integrate philosophy that was followed.

The Aerosonde UAV<sup>11</sup> developed by the AAI Corporation, Australia, has also been known to be used for scientific operations. It was the first UAV to cross the Atlantic Ocean, thereby directly meeting the long endurance requirements laid out in this chapter. It has also been used to gather data on hurricanes, tropical cyclones, carry a NASA microspectrometer for the gathering of high resolution atmospheric data and to fly extensive scientific missions in the Arctic region.

As with the autopilots and the inertial sensors, the UVS-International Yearbook<sup>12</sup> presents an almost exhaustive list of available UAV solutions in the Reference Section under the heading Civil/Commercial, Research & Dual Purpose UAS. It is suggested that UAV manufacturers with systems of interest be contacted directly to determine how products comply with the guidelines set out in this chapter. It should be remembered the abundance of different UAV manufacturers and designs are predominantly due to different missions and operational requirements.

---

<sup>9</sup> <http://www-abc-asia.ucsd.edu/MAC/secure/Index.htm>

<sup>10</sup> <http://www.aerucson.com/UAV/manta/index.htm>

<sup>11</sup> <http://www.aerosonde.com>

<sup>12</sup> <http://www.uvs-info.com>

### 4.3 Certification

Another aspect that is often overlooked when a COTS autopilot or a complete system is the issue of UAV certification for operation in civilian airspace. This topic is of key concern whenever UAV operations are being planned as autonomous aircraft are generally considered to be a safety risk to commercially operated aircraft. In all circumstances the local civil aviation authority should be contacted to determine the system operational requirements. Worldwide the operational requirements are still being formulated and the approval of a UAV operation is usually performed on a case-by-case basis. The normal process is to lay down a safety case for the operation of the planned UAV and to prove with the safety case the risk to the public and to civilian aviation have been adequately reduced through the addition of redundant sensor systems, certification of the autopilot system or through very strict operational procedures.

Some long-range UAVs operating in civilian airspace are the Global Hawk, Predator and the Aerosonde systems. Looking at these systems, it appears the whole certification process could be eased if the following building blocks are present in the UAV:

- RPV (Remotely Piloted Vehicle) mode, where a ground-based pilot controls the aircraft position and velocity and the autopilot acts in an assistive mode to stabilize the airframe while not being granted complete control over the system's motion. This is a great advantage for line-of-sight operations in particular high-risk areas;
- The availability of a transponder (both a radio for voice communication and an IFF (Identification Friend or Foe)) system to identify the aircraft within the civilian airspace; and
- The certification of the autopilot by the local civil aviation authority in the country where it was designed.

Apart from these guidelines, it must be remembered that the whole certification issue is still much debated and no final agreement has been reached as to when a UAV is considered to be safe for autonomous operation in civilian airspace.

## 5. Image Based Payload Systems

Long endurance UAVs are extremely well suited for applications where the payload consists of optical image sensors. However, in designing an image-based payload system for an endurance-based UAV application, certain additional requirements need to be considered. In this section we will consider these requirements in more detail. First we will provide a short overview of the typical image-based applications for UAVs in general, but more specifically those applicable to endurance UAVs. This will be followed by a discussion on the different aspects to be considered in the design of image-based payloads.

The US Department of Defense (DoD) categorizes payloads (Department of Defence, 2005) into the four general categories:

- Sensors (electro-optical, radar, signals, meteorological, chem-bio);
- Relay (communications, navigation signals);
- Weapons; and
- Cargo (leaflets, supplies), or combinations of these.

Almost all UAV applications reported sport an image-based payload in one form or another. The range of applications of these image-based payloads is varied, from surveillance and reconnaissance applications to remote sensing applications. However, image-based

navigation and tracking is becoming more prevalent, with the imaging system assisting with the navigation of the UAV as an additional sensor input to the other navigational sensors (e.g. GPS and inertial system).

Research in the past has focused on low-level control capability with the goal of developing controllers which support the autonomous flight of a UAV from one way-point to another (Doherty, 2004). Focus on research has moved from low-level control towards a combination of low-level and decision-level control integrated in sophisticated software architectures.

Image-based payloads have increased in sophistication, functionality and algorithm complexity. The ever decreasing size and cost of sensors and increasing processing power have ensured that more functionality can be provided for the weight and power budgets.

For sensor technology, miniaturisation of a specific sensor technology is a forerunner to cost implosion. Once sensors get cheap, the consumer market reaps them up in consumer products and possibly the high-volume military market (infantry) (Wilson, 2002). The automotive industry (a high volume market of approximately 60 million cars produced every year) is usually the last adopter, because it represents the worst combination of low cost and high reliability.

Situational awareness in the automotive market involves all kinds of sensors. Sensors with integrated lasers for 3D imaging or ranging will become significant, as can be seen in the parking-distance sensors now available in most vehicles, and the infrared night-vision detectors used by some cars for collision avoidance. For COTS design involving sensors, one should therefore carefully consider the life-cycle of sensor technology in the automotive industry.

With the number of sensors per system (including UAVs) increasing, the finite failure probability per channel (uncertainties per channel) could concatenate in the end until you can't trust the output. Such a multi-sensor approach requires a new system architecture. One has to calibrate from a systems point of view, where any combination of sensors can fail and the system will still function accurately. The system must be taught the net error, rather than compartmentalising the uncertainty, and how to accommodate it with correction algorithms. It is smart sensors combined with smart systems design (Wilson, 2002).

In considering the design of a long-endurance UAV, the design of the image-based payload system should be carefully considered to fit into the overall design specification of the long-endurance UAV. As was previously stated, the major factors in the design of a long endurance UAV is power efficiency and weight.

Intelligent UAVs will play an equally important role in civil applications. There is a desire for more sophisticated UAV platforms where the emphasis is placed on development of intelligent capabilities and on abilities to interact with human operators and additional robotic platforms.

Civilian and commercial missions of UAVs will drive the synthesis of UAV technologies (especially image-based payloads) to ensure a high degree of safety, facilitating the integrating of UAVs within the air traffic management system (Okrent, 2004). This is an important point to consider if UAVs are to be adopted on a large scale for use in a commercial sense.

UAV maturity should be understood at a number of levels: improvement in mission reliability and readiness, in operational safety and increased autonomous operation while at the same time experiencing a significant reduction in cost.

## 5.1 Overview of Applications

Before considering the detailed design considerations for long endurance imaging payloads, it is necessary to evaluate the range of applications for the imaging system, where each application drives its own design requirements. The list of image-based applications for UAV payloads presented here is bound to increase in the future and become out of date before publication, but it is worthwhile to list some of the image-based applications currently reported in the literature. Some specific applications are elaborated on more completely to identify key design issues.

### 5.1.1 Scientific Missions

A number of researchers throughout the world have documented the use of UAVs to perform scientific investigation of remote areas and aerial surveys for specific missions - land mapping, tropospheric sampling etc. (Niranjan , 2007). One of the essential tasks for any aerial explorer is to be able to perform scientifically valuable imaging surveys. The high-level of mobility, and unique observational perspective, provided by aerial vehicles makes them potentially extremely valuable tools.

Scientific research of any nature (environmental, atmospheric, archaeological, pollution, etc.) can be carried out by UAVs equipped with the appropriate payloads. An inconclusive list of scientific applications reported are the following (Okrent, 2004; Sarris, 2001):

- Atmospheric research;
- Geological surveys;
- Hurricane evolution and research;
- Oceanographic observations;
- Volcanoes study and eruption alert;
- Weather forecasting;
- Archaeological surveys;
- High accuracy terrain mapping
- Atmospheric heating measurement programmes;
- Cloud study programmes;
- Glacier and ice sheet programmes;
- River flow and discharge missions;
- Ozone layer studies and monitoring;
- and many others.

The payload for scientific applications is often more than just a visible imaging system, including multispectral imaging, LIDAR, and other types of sensors, mostly in combination. Satellites are the proverbial work horse when it comes to scientific image-based applications, especially with regards to monitoring and analyzing the natural environment. However, satellites and High Altitude Long Endurance (HALE) UAVs have complementary applications: Satellites provide worldwide coverage while HALE UAVs provide regional and local applications. HALE UAVs also have lower altitude, and therefore provide the opportunity of higher resolutions, typically 10cm to 5cm.

Most scientific studies utilising UAVs require data collection over extended periods of time and are therefore well suited to long endurance UAVs (Awan, 2007).

#### **Photogrammetric recording of archaeological sites**

Archaeological site recordings often use photogrammetric methods to obtain accurate 3D models. Photogrammetry is a research area concerned with obtaining reliable and accurate

measurements from noncontact imaging (Fisher, 2005). These applications require a combination of GPS/INS stabilisers for the imaging platform for highly reliable image acquisition (Eisenbeiss, 2006). Standard helicopters or airplanes with photogrammetric cameras are too expensive and do not allow flying close to objects or have the capacity for complicated manoeuvring. While the GPS/INS unit enables semi-automatic navigation along a predefined flight path, the stabilisers ensure a stable flight attitude and thus a highly reliable image acquisition (Eisenbeiss, 2005).

In a recent report (Bendeaa, 2007) an archaeological site survey was documented. The survey was conducted at an altitude of 100m. Each photogrammetric flight plan was designed setting the UAV speed at 15 m/s, which meant a shooting time interval of about 1,5 s (60 m) and 2,5 s (100 m) to get adequate frame overlaps.

For any photogrammetry application camera calibration is of great importance for the accuracy of the final product. This has an implication in the design of a UAV, especially when off-the-shelf cameras are used (e.g. Digital SLR cameras with zoom capabilities), as vibration becomes a factor, as well as lens movement during zooming operations.

The internal orientation parameters (focal length, coordinate of principal point and radial lens distortion) of the camera was estimated using a self-calibration approach. An a priori estimation was performed using a self-developed calibration software, but it was found a non stability of the radial distortion parameters. This was probably due to the fact that the lens is retractable, that means it move in and out during switching on/off operations.

A comparison between high altitude and low altitude UAVs found that a higher height allows the pilot to better control the UAV speed and to follow a straight line. On the other hand low altitude images are more detailed, allowing an improvement of the accuracy during the 3D feature extraction. The obtained 3D accuracy was found to be suitable for archaeological evidences mapping at a very large map scale.

### 5.1.2 Emergency Missions

UAVs are well suited to emergency missions. Reports on UAVs used for emergency missions almost always include imaging payloads, often with real-time video streaming. Some typical applications reported are the following (from (Okrent, 2004)):

- Disaster operations management;
- Fire fighting;
- Oil slick observations;
- Flood watch;
- Volcano monitoring;
- Catastrophic situation assessment;
- Search and rescue (looking for survivors from shipwrecks, aircraft accidents, etc.);
- Hurricane watch;
- Earthquake monitoring; and
- Nuclear radiation monitoring.

Most of these missions require extended time in the air, and also real-time video to the ground control station. This implies a good communications link with relatively large bandwidth, which impacts on the power budget of the UAV.

#### **Forest fire detection and monitoring**



Forest fire fighting often happens in rough terrains which need immediate line-of-sight communications to fire fighters. UAVs are starting to be employed in supporting the fire fighting efforts (Awan, 2007; Merino, 2002; Merino, 2006).

Frequent updates concerning the progress of a forest fire are essential for effective and safe fire fighting. Fire fighters need frequent and high quality information of a fire's development to conduct an effective and safe fire fighting mission (Casbeer, 2005). Low altitude UAVs can capture high resolution imagery and broadcast frequent updates to fire crews. In fire monitoring missions, the objective is to image the perimeter of the fire and upload the location of the fire perimeter (with associated imagery) to the base station as frequently as possible.

Since fire is growing and changing directions, UAVs need intelligent path planning ability using limited real-time information. They also need the intelligence to return to base (Casbeer, 2005).

Fire fighting monitoring requires that the UAV have long endurance. Depending on the area to be covered, a high speed communications link will be required over reasonable distances. This has a direct impact on the power budget of the endurance UAV.

### **Fire detection**

Some of the image processing issues to address in a detection application (Merino, 2002) are techniques for fire segmentation and techniques for fire geo-location. Feature matching methods are also used to track points employed by geo-referencing. To geo-locate fire features, a very accurate camera position estimation is required. Image processing techniques can be used besides GPS to help with the geo-referencing of the features.

In (Merino, 2006), multiple heterogeneous UAVs are used in detecting and localising fires. The heterogeneity here refers to different sensors employed on the various UAVs, all working in unison towards the same mission goals. Although it increases the complexity, the authors reported that it also provided several advantages, i.e. different sensors in the air which may be impossible to carry on one UAV.

The UAVs are reported to have motorised pan and tilt units to allow orientating the cameras independently from the body of the vehicle. Encoders are used to measure the pan and tilt angles. Various combinations of low cost infrared and visual video cameras are employed. The UAVs were further equipped with DPGS, gyroscopes, and IMUs. Some of the software functions reported in the software architecture are:

- Feature matching (to differentiate fire pixels from background pixels);
- Fire segmentations (employing various processing functions, i.e. histograms, thresholding, look up tables);
- Geo-referencing;
- Motion compensation (image stabilisation).

For geo-location, the sensors onboard the UAVs in (Merino, 2006) are used to compute, in a global and common coordinate frame, the position and orientation of each UAV itself and also of the sensors that are carried on board. For the latter, the UAV attitude angles measured by the IMU units have to be combined with those of the pan and tilt devices.

A lot of attention is placed on the mission aspects, especially with regards to the multitude of UAVs. The mission is decomposed in the following stages: fire search, fire confirmation, fire observation. The recovered position of the fire could be determined within 1 meter of the actual position.

One issue of concern is that of image compression for bandwidth conservation, as it may influence the image processing algorithms. Experimental work was needed to find the right compression factor. All communications were carried out using 802.11 wireless systems. Experiments demonstrated that if the UAV motion is smooth, speed moderate and the distance to the wireless base shorter than 100 meters a robust communication channel can be established. For other conditions a more robust data link would be required. As image processing is carried on board, the required bandwidth is considerably reduced and can be sustained by a radio-modem data link.

It was also found that sensor coordinate system can generate serious problems, especially in light of multiple UAVs cooperating.

### **Search and rescue support**

The UAV support for search and rescue missions is a complicated task requiring thousands of hours of search over large and complex terrains, again signalling the requirement for long endurance. The discussion to follow is mostly extracted from (Adams, 2007), and clearly shows the various issues involved in the application (which was wilderness search and rescue). However, also see (Westall, 2007) for a maritime search and rescue missions.

When studying classical search theory (in the sense of "search and rescue"), a critical factor in designing an optimal search is determining the instantaneous probability of detection by one glimpse of the target. An observer that must make a target classification in real-time must progress slowly enough to ensure enough glimpses of the potential target to obtain a satisfactory probability of detection. The goal of 100% target detection is in conflict with the goal of searching the largest area possible. This implies that long UAV flight hours will be logged.

The basic steps for a successful UAV searching for evidence include:

- Aiming the camera to make it likely that visual evidence appears in the video; and
- Identifying the evidence's location in order to guide the rescue team to the missing person.

Imagery is acquired by planning a path, flying the UAV and controlling the camera viewpoint to ensure that imagery is obtained of the complete search area. During this phase, the control variables are the speed and path of the camera's footprint over the ground.

Finding items of interest in the provided imagery is a challenging task for an autonomous algorithm. Design variables at this stage are pixel density, field of view, image stability, contrast between the sign (evidence) and background.

Locating a sign of the target with a UAV to constrain the search requires three activities:

- Analysing imagery;
- Localising the sign; and
- Refining the imagery.

In analysing imagery, the goal is to find the target's location. The key variable is the probability that a human can detect a target in an image given a set of image features, which is influenced by how the information is obtained and presented.

Localising the target is called geo-referencing. Localisation can be performed autonomously by using a GPS, the UAV's pose, triangulation, terrain information, and image features.

Some additional design considerations and technologies reported are the following (Adams, 2007):

- The ability to enhance raw video through stabilisation, mosaicking, and image enhancement;

- The ability to autonomously maintain height above ground; and
- The ability for the UAV and the support team to coordinate effectively.

### 5.1.3 Surveillance Missions

Airborne surveillance is applicable to a wide range of applications. The main objective of these kind of missions is to enable UAVs to acquire and interpret data in real-time, followed by decision-making in terms of signalling an alarm, while flying over a targeted area (Kontitsis, 2004).

The first applications for U.S. military unmanned aerial vehicles was surveillance, to be the “eyes in the sky” in operations where it was too dangerous to send manned aircraft or just too expensive.

“Eye-in-the-sky” surveillance could assist law-enforcement agencies in the protection of citizens and the integrity of borders. Road traffic, pipelines, power cables, forests, volcanoes, etc. could be continuously or selectively monitored.

Some typical applications reported are the following (from (Okrent, 2004)):

- International border patrol;
- Environmental monitoring;
- Law enforcement;
- Road traffic monitoring and control;
- Coastline monitoring;
- Maritime patrol;
- Drug traffic monitoring; and
- Crop and harvest monitoring.

Surveillance missions often have a endurance requirement, high altitude ability, video transmission, etc.

#### Road traffic surveillance

A good example of surveillance missions is that of traffic surveillance. A good research survey is presented in (Puri, 2004) providing an overview of the types of research being conducted. Traffic surveillance is a prime example of long endurance flights.

The mission of roadway transportation agencies is to focus on the needs of the travelling public. This requires collection of precise and accurate information about the state of the traffic and road conditions. It also requires timely information on road emergencies.

Aerial views provide better perspective with the ability to cover a large area and focus resources on the current problems. It is mobile and able to be present in both space and time. Satellites are not ideal in road traffic monitoring applications for the following reasons:

- The transitory nature of their orbits make it difficult to obtain the right images for continuous problems (e.g. traffic tracking); and
- Cloud cover on days with bad weather results in bad image quality.

UAVs can move at higher speeds than ground vehicles, fly in potentially dangerous conditions, view a whole set of network of roads at a time and inform the base station of emergency or accidental sites.

Typical applications of UAVs in traffic monitoring are the following (Puri, 2004; Nordberg, 2002; Rathinam, 2005):

- Incident response;
- Monitoring of freeway conditions;
- Coordination between a network of traffic signals;

- Traveller information;
- Emergency vehicle guidance;
- Track vehicle movements in an intersection;
- Measurement of typical roadway usage;
- Detection of specific road events (overtaking, U-turns);
- Estimation of various features of a vehicle such as velocity and type;
- Monitor parking lot utilisation; and
- Estimate origin-destination flows.

UAVs for traffic monitoring may be equipped with a range of interchangeable imaging devices and sensors:

- Day and night real-time video cameras;
- Infrared cameras;
- Multi-spectral and hyper-spectral sensors;
- Thermal sensors;
- Synthetic aperture radar (SAR);
- Moving target indicator radar;
- Laser scanners;
- Chemical, biological and radiological sensors;
- Road weather information systems to record the necessary information such as weather, fire and floods; and
- Communications hardware to relay data to the ground station.

From a software architecture point of view, a three-layer agent architecture seems to be prevalent (Coradeschi, 1999):

- A process layer for image processing and flight control;
- A reactive layer that performs situation-driven task execution; and
- A deliberative layer mainly concerned with planning and monitoring.

Barriers to the wide scale adoption of UAVs in unrestricted air space are the lack of standards and regulations international in the various civil aviation authorities. The FAA requires UAVs to have onboard “detect, see and avoid” capabilities to prevent in-air collisions. A fail-safe option for the mission must automatically apply if the ground to UAV communications link fails. Further, the communications regulatory environments also regulate the licensing of spectrum, which may inhibit the real-time transmission of high quality images due to a lack of bandwidth.

Based on the above discussion, some of the following observations can be made (from (Nordberg, 2002)):

- Tracking requires a certain amount of planning to be made by higher levels of system to predict where and how a vehicle is going to move on the ground, manage occlusions on the ground, etc.
- Another scenario is to make the UAV assist a ground vehicle to either intercept a tracked vehicle or to get a specific location in an urban area with traffic jams. This requires the UAV to be able to detect and estimate the size of the traffic jams, and to find free paths around it.
- A UAV should be able to autonomously navigate between points, track ground vehicles, and estimate various features and detect events related to individual vehicles or pairs or even large sets of vehicles.

- Advanced image processing tasks (road detection (Kim, 2005), landmark tracking, and motion detection) require spatial or spatio-temporal filtering of the camera images. This includes filtering for detection of lines/edges, estimation of their orientation, detection of corners and other local symmetries.

#### 5.1.4 Communications Missions

The long endurance nature of UAVs with high altitude capabilities make UAVs suitable to act as communication relay stations (Okrent, 2004). Some applications in this regard are:

- Broadband communications;
- GPS augmentation system;
- Telecommunication relay service; and
- Pseudo satellite.

#### 5.1.5 Industrial Applications

With the commercialisation of UAV airframes, the lower cost of COTS-based vision payloads and increasing experience, it is to be expected that industrial applications should follow. Some examples of industrial applications are the following (Okrent, 2004; Sarris, 2001):

- Crop spraying;
- Nuclear factory surveillance;
- Mining and exploration;
- Power line monitoring;
- Pipe line monitoring; and
- Agricultural applications.

Some discussion on some of these industrial applications will now be provided:

##### High voltage power line monitoring

Power lines need to be monitored for several reasons, e.g. detecting cracks in isolators, monitoring undergrowth to prevent flashovers due to fires, etc.

Most often power line monitoring is done by foot patrolling or by using helicopters. Both of these methods require manpower and time, both costly. Helicopters are used for this purpose; however this is a dangerous and costly option. For these missions, pilots have to fly the helicopter at low altitude and close to the power lines. This is a tedious job with a high level of fatigue as the pilot has to keep the helicopter on a fixed altitude. UAVs are very well suited to this (and similar) kind of problem (Awan, 2007).

For power line monitoring missions, images are usually recorded by the UAVs video camera and transmitted to the ground station, where the operator can interrupt the flight plan at any time to change the zoom of the power line monitoring camera (Sarris, 2001).

The image-based payload plays an important part in these missions. Some of the issues to consider are the following for these kinds of missions:

- Endurance. The power lines to be monitored may be tens to hundreds of kilometres in length, and constant refuelling or charging may delay the process.
- Automated flight. As a result of the distances and times involved, the requirement is that navigation need to be automated (through GPS way-points), but will also include visual tracking of the power lines.
- Zoom levels. Tracking of the power lines require vision at some distance. Isolators and possible cracks need to be investigated much closer.

- Multispectral imaging. The imaging payload for this application may require multispectral imaging for various purposes, i.e. visual imaging for navigation and general inspection, ultra-violet to detect corona effects, etc. IR can also be used for tracking purposes.
- Automation of visual monitoring and detection. The level of repetitiveness for this kind of mission is high, with the result that artefacts of importance may be missed due to fatigue and boredom of an operator.
- Large on-board processing power and memory. The image processing algorithms involved are complex, in addition to the high resolution required. This will impact on the processing power and the memory on-board the aerial platform.

### **Surveillance of pipelines**

Pipeline conditions are causing damage and environmental issues, with an increasing demand for some form of inspection technology. Pipelines are also vulnerable targets for terrorists and therefore need to be monitored from a security point of view (Awan, 2007).

Similar to traffic monitoring missions, satellite monitoring of pipelines presents some problems. An additional problem is that the plumes (methane) leaked from pipe lines disperse into the atmosphere rapidly without being properly detected. Therefore UAVs may be the best option to perform this task. Presently, most of the pipelines are monitored with helicopters or ground inspections. Many gas companies in the USA, Russia, France and Germany are using UAVs for pipeline monitoring on an experimental basis.

The design considerations for monitoring pipelines are similar to that of power line monitoring, although there may be some differences in the multispectral imaging and image processing algorithms.

There are various environmental and human activities that need to be monitored on a routine basis to ensure the safety of the huge investment in gas pipelines. Some of the monitoring activities are:

- Construction Work;
- Earth Movement and Excavation;
- Lying of pipes, cables etc.;
- Erection of buildings;
- Soil upheaval and erosion;
- Water logged surfaces;
- Plantation of shrubs and trees; and
- Discolouring of vegetation.

The purpose of an aerial imaging platform in such a scenario is to perform object detection and location, and moving vehicles. The spatial requirement for aerial images translates to the following:

- Monitoring strip of 200m
- Metallic machinery 2m X 1m
- Objects e.g. pipes 0.2 m X 5 m
- Excavations 0.5m X 5m 0.5m
- Tree tops diameter : more than 2 m
- Location accuracy : 5m

The UAV platform should also ensure weather independency and surveillance frequency of more than once in a week.

### **Mineral exploration and exploitation**

The remote sensing payload ability of some UAVs has enabled it to collect data for exploration of minerals deposits (Awan, 2007).

### **Agricultural applications**

UAVs with IR and visible-light optical sensor payloads take images of crops. These images are combined into colour graphics to show how the crop is growing and indicate areas of blight. In addition to the above, moisture levels in the soil and the amount of plant life can also be measured.

In Japan, UAVs are used extensively for the purpose of crop spraying.

### **5.1.6 Navigation**

The autopilots found in most of the reported autonomous or semi-autonomous UAVs require real time information of the UAV to accomplish their tasks, e.g. the attitude, velocity, position and acceleration. This data is then passed on to the flight control system which, based on a PID control law, actuate the servos to deflect the control surfaces. It is important that if onboard processing of payload is required that there is redundant processor along with flight control processor (Niranjan, 2007).

In certain environments (urban or in forests), satellite visibility may be limited. In these cases, the GPS accuracy may be negatively impacted. In such cases, it is necessary to determine position and attitude through other means, such as through visual means (Caballero, 2005). An example of such an application will be that of a Mars rover.

Image processing methods are also used for safe landing, on stationary bases or on moving targets such as ships.

## **5.2 Design Considerations for Image-Based Payload Systems**

### **5.2.1 General Considerations**

In designing image-based payload systems for UAV applications, one should consider the following generic issues:

- Flexibility – the ability of an UAV system to perform not only its original mission, but additional missions which were not originally envisioned. This should be done without change to the system;
- Adaptability – the ability of a system to perform not only its original mission;
- Upgradeability – the ability of a system to be changed (or reconfigured) enabling it to perform additional missions;
- Reliability – the ability of a system to be flexible, adaptable and/or upgradeable while still being able to operate for many years; and
- Scalability – the ability of a system to perform its original mission to a much greater or smaller extent.

In general, the major design decision for long endurance UAVs will be based on a trade-off between power requirements, weight, functionality, reliability and cost.

### **5.2.2 Integration Considerations**

A UAV can be defined as consisting of several subsystems, where each subsystem provides some necessary functionality. The concept of “loose coupling” whereby subsystems are not

tightly integrated, but rather coupled in a manner allowing for at least semi-independent evolution, helps engineers design highly complex systems (Dahlgren, 2006).

The concept of a “performance range” for subsystem specifications will likely lessen the number of hard technical requirements, enhance the opportunity for system evolution, decrease program risk, and improve the opportunity for major systems to be delivered within the overall performance, schedule and budgetary constraints.

### 5.2.3 Image Processing Algorithms

Image processing is a general term covering all forms of processing of captured image data. Often, the term machine vision is also used, which is a general term for processing image data by a computer. There is a tendency to use the term “machine vision” for practical vision systems, such as industrial vision systems (Fisher, 2005) used in manufacturing.

The image processing field is a mature field, and an extensive knowledge and application based is available. There is an extensive set of models, algorithms and computational structures that are ready for implementation.

There is no shortage of models and algorithms for image processing; however there is a shortage of effective, well engineered implementations. Implementing an algorithm into a hardware system is a non-trivial task (Barrows, 2002) that will require skill, patience and experimental work.

A good start is to read any one of several machine vision books available. A development tool commonly used is Matlab, together with an image processing toolbox which provides a set of basic image processing algorithms. General image processing frameworks are available (e.g. Intel’s OpenCV) that can shorten custom development time; however this depends on the hardware and operating software architecture.

For long endurance UAV applications, the choice of image processing algorithms will play an important role in the design consideration. As the complexity of the algorithm (and hopefully the functionality as well) increases, the processing requirements will also increase. Another design consideration is also the resolution of the images to be processed by the algorithms. As the image resolution increases, the number of pixels to process increases too, adding to the processing burden.

Another approach, depending on the application, is to do just enough image processing on-board the UAV (e.g. for navigational purposes) and then do the complex processing at the ground station. In this case, one should consider the trade-off between memory requirements and communications requirements. However, long endurance UAVs by definition may capture data (images) for a long time during its mission, which implies that it may require access to large on-board memory.

Some common image processing tasks will be now discussed in the context of long endurance UAVs:

#### **Image enhancements**

Image enhancement is a general term covering a number of image processing operations that alter an image in order to make it easier for humans (or another algorithm) to perceive (Fisher, 2005). There are several techniques to enhance the resulting image, with increasing degrees of complexity. Obviously, the specific application will drive the development and complexity of the image enhancement algorithms. The first rule is to capture the best possible image in the first place, by considering the optical path design (including the sensor), the resolution, shutter speed, aperture, etc.



Some of the simpler image enhancements that can be done algorithmically are the following:

- Image denoising;
- Contrast adjustments;
- Histogram equalisation;
- Colour enhancements;
- Blurring;
- Sharpening;
- Cropping;
- Scaling; and
- Rotating.

These operations can usually be implemented effectively on normal processors (CPUs) or digital signal processors (DSPs). Translations (e.g. rotation) can become computing intensive.

However, in challenging applications, more advanced image enhancement algorithms will be required. As an extreme example, atmospheric turbulence (or heat shimmer) can become a severe problem on a relatively hot day on images taken over a large horizontal distance. This example may be quite relevant to long endurance-based UAV missions. The resulting image may blur and lose too much detail to be useful. However, compensating for this is still an open research problem with complex algorithms, requiring high levels of processing power.

Super-resolution of images is also possible using several low resolution images of the same object viewed from different angles. The implication of this is that in video sequences, frame rate can possibly be exchanged with resolution – again depending on the application.

### **Object and event recognition**

An interesting consideration for long endurance surveillance-type missions is the resulting long video sequences that may result. Most of these footage will be eventless and therefore of no interest. Automated scanning of this video footage (in addition to enhancements) for significant events or objects will greatly increase the usability of the data (Li, 2005).

However, for navigational purposes, object recognition may be important.

### **Image Mosaicking**

Image mosaicking is the composition of several images, to provide a single, larger image with covering a wider field of view (Fisher, 2005). Depending on the application, images collected may be required to be stitched before further processing is possible (Horcher, 2004). For this purpose, good feature points are necessary. Good feature points invariable require good edges or corners, as often found in roads, forest edges, and a stream course. However, with more uniform textures in pictures, determining good feature points can become a problem. Better feature identification algorithms (e.g. SIFT) may be an option. However, state information from the on-board payload sensors may be an additional input.

Design considerations here will be the following:

- Large resolution images may be difficult to process on-board the UAV; and
- Use state information from the other sensors as additional input.

## **5.2.4 Image and Video Compression**

In the design of long endurance UAVs, one should also consider the use of image and video compression as part of the design trade-off. When considering compression, redundancy is

removed, substantially reducing the size of the images. Typical UAV video sequences may be well suited to good compression ratios, as the scenery doesn't change too often.

In the selection process of an image compression algorithm, one should consider the lossy nature of the algorithms. Certain compression algorithms permanently remove information without too much loss of visual quality (called lossy compression). This may be adequate for visual perception, and if that is the only application of the video, one should seriously consider this. An example of such a lossy compression algorithm for images is the jpeg compression algorithm. However, if high quality images are required, especially for image processing algorithms, one should rather consider loss-less compression algorithms.

Some benefits of using compression algorithms are the following:

- Reduced onboard memory requirements for the same sequence;
- Longer flight times as more images may be stored on the same onboard memory footprint;
- Reduced bandwidth requirements from the onboard communications link; and
- Higher quality pictures for the same memory footprint;

There are certain issues to consider:

- Increased processing requirements, depending on the algorithm employed;
- The trade-off between compression ratios and the quality of the images;
- The delays introduced by the compression algorithms on video transmission; and
- The sensitivity of the compressed images to bit errors. Bit errors may be introduced by several noise sources, e.g. EMI onboard and normal transmission errors. Error correction coding should be considered when compression is introduced. This may add to the processing complexity.

In general, taking the operating environment into consideration, one should experiment with different algorithms, compression ratios and error correction coding schemes.

### 5.2.5 Communications Link

The communications link is an important design consideration for any UAV design, especially as it relates to the power budget. However, special consideration should be given to the imaging payload requirements for the communications link. As the distance between the UAV and the ground control station increases, the signal-to-noise ratio of the transmission link will deteriorate, with the introduction of additive errors. Further, if there are reflections in the signal due to mountains and buildings, fading of the transmission link can be expected.

Local signal interference may also reduce the throughput rate. In cases where the IEEE 802.11 series of protocols are used (e.g. WiFi) for the transmission links, one should consider the contention nature of the communications link and its effect on throughput.

Images and video streams invariably translate into high bandwidth requirements for the communications link. As the resolution increases, the bandwidth requirements increase. In video sequences, an additional consideration is the frame-rate. The higher frame-rate may require higher bandwidth, but may be required to detect fast-moving artefacts.

Some design considerations for the communications link with regard to the image payload are the following:

- Consider using only the necessary frame rate for video necessary. This will be determined by the requirements of the application, e.g. sampling rate of object movement, averaging of frames, etc.

- Consider using the necessary resolution. Again, this directly impacts the bandwidth requirements of the data link;
- Perform some image processing onboard to lower the transmission requirements. As an example, event detection can be used to only transmit sequences of interest; a region of interest can be determined on-board to transmit only those areas to the ground station;
- Consider the use of image compression, together with the trade-off required;
- If real-time imaging is not required, consider increasing the on-board memory for storage of large sequence;
- If real-time imaging is required, determine the delay, image quality, etc. required and incorporate it into the communication link design;
- Consider the various modulation schemes, communications protocols, as well as Medium Access Layer (MAC) protocols for optimal usage of the available frequencies;
- Evaluate the different frequency bands available for use in the region, i.e. the various ISM-band frequencies, the bandwidth afforded and the transmission properties of the band.

In most cases, a combined trade-off will need to be made, taking a multi objective optimisation approach.

### 5.2.6 Processing Considerations

Image processing algorithms by nature are processing intensive. Image processing algorithms are also dependent on image resolution. As the complexity of algorithms increase, the requirement for processing power can also be expected to increase.

The typical selection of the processing unit for image processing applications are usually made from various families of Digital Signal Processors (DSPs), Field Programmable Gate Arrays (FPGAs), and Central Processing Units (CPUs).

The expectations are that Moore's law will continue for at least the next 5 to 10 years, and provide increasingly capable processing hardware (Barrows, 2002).

#### Parallel processing

It is well known that most image processing algorithms are well suited to parallel processing architectures. Massively parallel digital processing is no longer exotic but mainstream, and will become even more important in the future. The lower cost of parallel architectures is driven by higher volumes. Note that by using parallel processing, Moore's Law growth rate is doubled. However, this increase is only achieved if the applications are implemented to utilize parallel architectures (Barrows, 2002). A simple increase in processing cores (as done in the Intel and AMD processors) increases the inter-process communications burden. The thread processing model introduces a level of complexity, and run into scaling problems.

Since much of image processing consists of repeating the same instruction over and over again on different data, it makes sense to use parallel architectures in future machine vision systems. There remains the challenge of knowing what algorithms to implement in such a processor for a given application.

In the past few years, the use of Graphics Processing Units (GPUs) for general purpose processing has steadily increased. The recent (2008) population of GPU architectures are all based on stream processing architectures and very well suited to image processing. The literature on image processing algorithms on GPUs is exploding with most papers reporting

at least an order of a magnitude (or two) jump in speed. GPU technology is driven by the gaming market, which has exploded in that past two years due to the proliferation of gaming consoles. The implication of these high volumes is the low cost of these GPU cards. The interesting consequence of this is the real-time execution of complex algorithms.

However, there are a few caveats to consider before selecting GPU technology, especially as it relates to long endurance UAVs (Wosylus, 2008):

- GPUs are approaching the 2 TFLOPs (1012 floating point operations per second) on a single card at a low cost, providing in most cases more processing power than required. However, the power requirements of these cards are extremely large (150 watts or more), and definitely not suitable for most long endurance UAV applications;
- Programming for GPU architectures is not simple and requires a fair amount of retraining. Porting algorithms to the GPU can be time consuming and costly;
- Standard GPU cards for consumer gaming computers are often discontinued after just a few months, this being the typical lifecycle for standard computer boards intended for the consumer market. This has serious implications on long term support and modularity;
- The image processing bottleneck will probably not be based on the processing power anymore, but on the data flow between sensors, CPU and the GPU;
- Reliance on products from the consumer market (such as GPU cards), will be rewarded by significant expenditure during the product's lifecycle: frequent driver updates, limited reliability due to fan failures;
- The physical dimensions of consumer boards and their cooling designs often conflict with the embedded principles of compact dimensions, simplified cooling and standardised form factors; and
- The option of designing proprietary graphics capabilities is even more problematic, since the components used could be discontinued before the finished design goes to market.

To utilise the power of GPUs the following suggestions are made:

- Consider the selection of newer embedded boards that are released with PCI-e ports, allowing for the integration of GPU-based boards into the design;
- Lower power versions of GPU cards are available, but with a subsequent decrease in processing power. Through experimentation, determine the minimum level of processing required and select that GPU card – this will limit the power requirements;
- Develop algorithms on an open platform (we suggest OpenGL) to gain as much hardware independence as possible. This will also provide some protection from hardware changes and newer versions of the standard, as OpenGL is backwards compatible;
- Some embedded processing boards are released with an integrated, low power GPU onboard, which are OpenGL compliant; and
- Distribute the processing of the algorithms in such a way that the compute intensive algorithms run on the ground station where a GPU can be introduced, while lighter processing tasks takes place on-board the UAV. However, this translates the problem from a processing problem into a communications problem, i.e. the high bandwidth required to transmit the video stream to the ground station. This will obviously be dictated by the specific application. Algorithms intended for navigational purposes, as

will be safety and avoidance tasks will most likely stay on-board, while more mission-related algorithms may be transmitted to the ground station for processing. For long endurance UAV payloads, the processing power has a direct affect on the power consumption.

### 5.2.7 Mounting

In the development and selection of an image-based payload system, special attention must be given to the mounting of the UAV payload, as the importance of mounting cannot be stressed enough (Kahn, 2001).

Some reasons to regard the mounting of the payload system are the following:

- A good mount will save the system from failure many times over;
- A good mount will make the electronics run more reliable; and
- A good mount design must be tested by extensive experimentation.

As part of a long endurance mission, the payload will be submitted to prolonged and high levels of vibration. For a vision-based payload, the vibration may adversely affect the basic functioning, but also the accuracy of the devices. For this reason, one need to conduct a wide range of vibration tests of components and modules to get an idea of the level of vibration each device can withstand. The payload vibration mount must then be designed to meet the needs of the most sensitive device.

A rule of thumb is to try to make the device that is to be damped as heavy as possible to increase its inertia (Kahn, 2001). The more the inertia, the more force is needed to accelerate the box. This large inertia works with the damping material to isolate the hardware. Therefore, from a vibration damping point of view it is advisable to place devices together in a single box (to increase weight) and then to isolate the box as a whole. However, this may introduce additional EMI problems.

The materials to be used in the mount should also be selected depending on the level of damping needed. The damping material under consideration should have two key properties:

- Strong and tear resistant; and
- Soft and flexible.

Additional considerations for the mounting of the long endurance UAV payload are the following:

- It should provide good stability, especially if accurate measurement sensors are to be mounted on it;
- If required, it should provide weather protection;
- It should allow for easy access to the payload to affect changes and replace modules;
- It should provide general protection for the electronics; and
- It should be light weight.

### 5.2.8 COTS Consideration

One of the biggest cost-raising factors that manufacturers have to deal with in the UAV industry is the purchasing of parts. The relative small (but growing) number of suppliers in relation to the manufacturers gives them the opportunity to suppress the market by providing their products at high prices and low variety.

A lot of the sub-assembly parts come from the area of high technology, which makes them expensive to acquire by nature (Sarris, 2001).

“Plug-and-play” design allows for any new device, so long as it satisfies the standards of the system, to be inserted into the system without needing to do any software configuration. Advantages of using COTS components are the following:

- Less expensive; and
  - Utilise industry standards in power, size, and communications data buses.
- Some COTS industry standards to consider when designing a long endurance UAV are the following:

- Form factor (physical dimensions), e.g. PC104 for processing boards;
- Processor type;
- Communications; and
- Power requirements.

One issue to take cognisance of is that many modules of a supplier are of the “closed-modular” design, modular within a specific vendor’s range (Kahn, 2001). By restricting the mating characteristics of modules it becomes difficult and expensive to take advantage of new technology. This will be loosely coupled.

Maintaining the modularity while using industry standards allows for future upgrades and low-cost parts replacements.

### 5.2.9 Optical Components

In the design and selection of optical imaging components, there are several issues to consider. Again, the weight factor comes into play, but certainly also quality factors (lens quality, camera quality, electrical interfaces and connectors). One should consider the whole optical path when designing the image-based payload. A suggestion is to consider a good machine vision handbook on the design of the different aspects involved (See Handbook of Machine Vision (Hornberg, 2006)).

Image and video standards are evolving all the time and the standards are driving the costs down. HDTV formats are being introduced in consumer cameras, allowing for high definition video. This aspect should be taken into consideration when selecting imaging components as following standards generally drives down the cost and increase modularity. Image stabilization is critical to obtaining usable information (Department of Defence , 2005). Technology improvements in stabilization technology (electromechanical and electromagnetic) permit nominal sensor mounting systems to achieve stabilization accuracies in the tens of micro radians.

### 5.2.10 Human-Machine Interface

The design of an operator interface (ground control station) and the UAV autonomy is essentially a problem of human-robot or human-machine interaction, and a “catch-all” solution for all aircraft and all applications is unlikely to emerge (Adams, 2007).

UAV-human interaction design is fundamentally interrelated with UAV autonomy design, and a multi-dimensional trade-off between precision, response time, neglect tolerance, portability, and team size. It is desirable to develop autonomy and operator interfaces that span multiple application domains as much as possible.

The capabilities of a particular combination of airframe, autopilot, and control algorithm delineate the set of affordances that frame the human-UAV interaction space, and the set of constraints on the kinds of tasks that can be performed.

Increased AUV autonomy may produce:

- Higher neglect tolerance;
- Decreased operator workload; and
- Better fan-out ratios.

Autonomy can also result in negative consequences (Adams, 2007):

- Reduced situational awareness;
- Difficulty in supervising autonomy;
- Increased interaction time; and
- Increased demands on humans and autonomy, the “stretched system” effect.

### 5.2.11 EMI/RFI

EMI/RFI integration is the hardest part to understand (Kahn, 2001). A computer with an oscillator may not work together with other components, e.g. it interferes with the radio control subsystem, and can cause complete loss of control (Kahn, 2001). For long endurance UAV missions, this can become a problem as long distances come into play with subsequent lowering of signal to noise ratios in the communications/data link. Shielding should be carefully considered. However, as remarked in (Kahn, 2001), it is mostly a trial and error process to find part causing problems.

### 5.2.12 Geo-referencing

Photogrammetry in general deals with the three dimensional object reconstruction from two dimensional imagery (Cramer, 2001). To fully utilise UAV-acquired, remotely sensed imagery for applications such as change detection or situational awareness, the imagery must be geometrically corrected and registered to a map projection. This process is referred to as geo-referencing which requires the scaling, rotating and translating from the image coordinate system to the map coordinate system (Hruska, 2005).

Traditionally, ground control points were used to register the imagery. However there are a number of issues with using ground control points with UAV missions:

- There is a high cost associated with the collection of ground control points;
- With many missions performed by UAVs, the ground control points are either not available or impossible to obtain;
- The small footprint of low-altitude UAV acquired imagery complicates the geo-referencing process because such imagery lack distinguishable ground control points.

The introduction of low-cost inertial and optical sensors has advanced the field of vision-based navigation. In these systems, information extracted from digital images is combined with inertial measurements to estimate position, velocity, and attitude.

Direct referencing high-resolution still imagery from small UAVs requires tight integration between the Global Positioning System (GPS), an Inertial Measurement Unit (IMU) and an imaging sensor to acquire exterior orientation parameters at the time of image exposure (Veth, 2008).

Sensor placement should be driven by two objectives (Hruska, 2005):

- Isolating the inertial measurement unit (IMU) from the airframe vibrations, avoiding differential movements; and
- Minimizing boresight misalignment (any offsets between the GPS antenna, IMU and the perspective centre of the imaging sensor).

Synchronisation refers to referencing the individual sensor components to a common clock and input trigger (Hruska, 2005). Even small errors associated with improper synchronisation can have a serious impact on the direct referencing process and mission success.

Prior to the use of the system for mapping purposes, calibration must be performed. This concerns both the calibration of individual sensors (aerial camera or an IMU) and the system calibration due to the aircraft mount. Thereby the differences in orientation between the IMU and the image sensor(s) – known as boresight orientation(s), must be determined (Legat, 2006, Skaloud, 2003).

The relative orientation between the inertial and optical sensors is a critical quantity which must be determined prior to operation of the system. The accuracy with which the relative orientation is known effectively sets the lower bound for the navigation accuracy of the system.

The ultimate goal of the alignment process is to determine the relative orientation between an optical and inertial sensor, and more specifically, the sensitive axes of both sensors. The methods used to estimate this orientation fall into two categories: mechanical and estimation-based techniques.

Mechanical techniques use mechanical measurements (such as laser theodolites) to determine the relative orientation between known fiducials on each sensor. This method requires knowledge of the relationship between the sensitive axes of the sensors and the external reference fiducials, which is subject to unknown manufacturing errors. In addition, depending on the required accuracy, this method requires external equipment which is not really suitable for use in the field.

Estimation-based alignment techniques utilise actual sensor measurements while subjecting the system to known conditions. In one method, the sensors are mounted on a calibrated pendulum while imaging a reference pattern. The orientation of the scene detected by the optical sensor, combined with the current local gravity vector, is used to estimate the relative orientation and inertial sensor biases.

These current approaches require dedicated equipment which would increase the difficulty of field calibrations. In addition, these “captive” techniques separate the calibration and navigation functions of the system and cannot compensate for time-varying errors due to temperature changes, flight profile, flexure modes, etc.

In the most ideal case, all sensors are attached to a common rigid mounting structure, preventing variations of their relative positions and orientations. However, this is not always achievable and the effect of this must be considered in the design.

Several accuracy problems can be experienced related to reliability (instrument and/or data quality) or incorrect use (unstable sensor mount, uncompensated effects due to platform stabilisation, or inadequate datum/projection transformation procedures). A common error is the placement of the GPS antenna at another, remote position on the UAV. With a stabilised IMU/GPS platform, rotations of the stabilised platform introduce position offset change (lever arm) of the GPS antenna from the IMU (Legat, 2006).

Potential error sources in direct geo-referencing that may diminish the quality of data (Legat, 2006) are the following:

- Lack of rigidity of the sensor assembly, including lever-arm variations caused by the platform stabilisation;
- Synchronisation errors or non-compensated sensor delays, e.g. time shifts between a camera trigger command and the actual shutter time of the camera;



- Calibration errors of sensor lever arms and boresight angles or failure to apply these parameters correctly; and
- Erroneous settings or assumptions of the GPS/INS processing.

### 5.2.13 Power Requirements

The goal of the payload system is to gather and provide accurate data. Any disruption in power or disturbances may affect the integrity of the information.

The power system helps to transmit interference between components of the UAV. As an example, components start and stop at different times, causing power spikes on the power bus. This can reset other devices, causing another spike, eventually leading to periodic interference. In (Kahn, 2001), the author experimented with different configurations and components and suggested the use of DC-DC converters, as it will save valuable time in system integration. These converters are isolated, separating the interference and power spikes from one device to the rest of the power bus. However, one should determine through experimentation which devices work together.

Sensors (including optical) are getting smaller, and more energy efficient. However, as sensors get smaller, power dissipation densities increases substantially (Wilson, 2002). The direction all sensors will be moving is toward un-cooled. The main reason for this is cost. Un-cooled IR sensors would also reduce the weight, size and power requirements. The final limitation on the size of IR sensors is dependent on how far you want to see and the optics you put in front of it. The electronics will continue to shrink and get cheaper, but at some point you reach the limit on physical size because of the optics you're looking through.

Every component of the aircraft, sensor, and data link strives for small size, weight, and power consumption. For endurance UAVs, batteries with high power/weight ratios are important to maximize sensor capability and endurance.

### 5.2.14 Data Storage

One of the consequences of long endurance UAV mission is that large amounts of data will be collected and stored, mostly onboard. Onboard storage of sensor data in the terabyte class is a goal that the USA Department of Defence is pursuing (Department of Defence , 2005). Storage of complex imagery or phase history of radar data onboard can substitute for the extremely wideband data links required for near-real-time relay. Similarly, storage of the full output of a hyper spectral sensor will allow transmission of selected bands during a mission and full exploitation of data post-mission.

A 1.4 Terabyte storage capability coupled with an imagery index system and IP-enabled interface has been demonstrated on Global Hawk (Department of Defence , 2005). Known as the Advanced Information Architecture (AIA), this system permitted the capture of over 3 days of full resolution Global Hawk imagery and enabled users to access the imagery using internet search tools. The storage system and IP server were constructed using COTS components and integrated into the existing space allocated to the recorder suite.

### 5.2.15 Software Design Considerations

System software development and integration is a major challenge for UAVs as payload functionality and complexity increases. UAVs are getting more commercialised and long term support of complete systems will be required. A consequence of this is that careful consideration will have to be given to software engineering aspects. As can be expected,

different tools, modelling abstractions and engineering skills are utilized at various stages of a typical UAV development project.

In (Joshi, 2002) the author suggests a software framework as a domain-specific software architecture that provides the means to interconnect software subsystems. A software framework needs to provide the “plumbing” necessary to integrate software at different levels of abstraction. Frameworks provide partially-implemented patterns of behaviour that are finalized for a particular application.

The use of a software framework can drastically reduce development time while creating robust and flexible application software. A software framework will also provide well-defined integration mechanisms that help reduce development time.

A suggested UAV software framework that combines a hierarchical software component architecture is suggested in (Joshi, 2002) but similarly in (Wilson, 2002):

- Software is developed at various levels of functionalities in a UAV;
- At the lowest level, the drivers that interface with the hardware are found. This layer abstracts the hardware in a meaningful way for use at higher levels of functionality;
- The middle level is the low-level servo controls, necessary to achieve primitive control behaviours. It needs periodic sample loops running at fixed rates; and
- The last level adds higher levels of intelligence and controls. Typically event-driven behaviour, conditional logic and sensor-based decision making.

Modern UAVs are inherently distributed systems involving multiple processor nodes (Heintz, 2004). Therefore, a software framework for UAVs should also provide a communications infrastructure to enable deployment of distributed systems. Adaptation of distributed software to maintain the best possible application performance in the face of changes in available resources is an increasingly important and complex problem (Karr, 2001). The use of middleware for real-time embedded applications is found in several UAV applications, with most referring to the Corba middleware architecture.

Key characteristics of software frameworks and their impact on UAVs are listed in the following:

- It should be component-based. Component-based design facilitates reusability, clarity, reconfigurability and interoperability;
- The separation of interfaces from implementations. Benefits derived from this is replaceability (components can be replaced with others), extensibility (software can be extended), and the ability to leverage domain expertise;
- Hierarchical architecture. This provides complexity management (software elements can be packaged into coherent components), high-level programming, and scalability and layering (higher levels of abstraction can be realized by combining low level components); and
- Enhance integration capabilities.

## 6. Conclusion

Traditionally the field of inertial navigation systems was limited to high cost applications. However, recent advances in low cost MEMS based inertial sensors have resulted in the development of inertial navigation systems for the commercial market. The availability of these low cost navigation systems enabled a number of applications ideally suited to commercial UAV operators. In this chapter a number of applications for long endurance

UAV were discussed. Long endurance UAV flights require a number of aspects to be taken into consideration during the design phase. In section two an overview of potential renewable power sources for long endurance UAVs were presented. It was shown how a hybrid combination of photovoltaic cells and Li-Po batteries can fulfil the requirements of a long endurance UAV power source. Fuel cell power sources are attractive power sources for shorter duration UAV flights.

Section three showed by coupling the low cost inertial navigation system to a suitable control system how a complete navigation solution can be provided for long endurance UAV flights. A number of control techniques are discussed enabling the construction of autopilots for autonomous flight applications.

The field of image processing is a rapidly developing field. Since imaging sensors are ideal UAV payload sensors, advances in image processing directly benefits many UAV applications. A number of sensor payload design consideration are discussed with regard to long endurance UAV missions.

In an overview paper in 2007, Kenzo Nonami (Nonami, 2007) indicated the following aspects as important future research areas for UAV civilian use:

- Formation flight control (for data relay, in-air refuelling, observation work) with a possible flight control accuracy in the cm-order;
- Integrated hierarchical control in order to fly different classes of UAVs simultaneously. An example sited is that of coordinating various sizes of UAVs and MAVs with a larger supervisory UAV;
- High altitude flight, e.g. flights in the stratosphere for scientific observation missions;
- High precision trajectory following flight;
- All weather flight;
- Collision-avoidance systems;
- Intelligent flight control and management systems; and
- Advanced reliability.

Long endurance UAVs are an empowering technology for a number of previously unexploited applications which are now within reach of the civilian commercial market.

## 7. References

- Adams, J.A.; Cooper, J.L.; Goodrich, M.A.; Humphrey, C.; Quigley, M.; Buss, B.G. & Morse, B.S. (2007); Camera-equipped mini UAVs for wilderness search support: *Task analysis and lessons from field trials*, Byuhcmi Technical Report 2007-1
- Awan, S.H. (2007); UAV applications in atmospheric research, *MSc Aerodynamics*, Cranefield University School of Engineering
- Barbir, F. (2005); PEM Fuel Cells: Theory and Practice (Sustainable World Series); *Academic Press*; ISBN-10: 0120781425, 978-0120781423
- Barrows, G.L. (2002); Future Visual Microsensors for Mini/Micro-UAV applications, *Proceedings of the Workshop on Cellular Neural Networks and their Applications*
- Bar-Shalom, Y. & Li, X. (2001); Estimation with Applications to Tracking and Navigation; John Wiley & Sons; ISBN - 047141655X; Hoboken, NJ, USA
- Bendeaa, H.; Chiabrandoa, F; Tonolob, F.G. & Marenchino, D. (2007); Mapping of archaeological areas using a low-cost UAV - The Augusta Bagiennorum test site,

- Proceedings of the 21st International CIPA Symposium*, 01-06 October 2007, Athens, Greece
- Bird, R. E. & Halstrom, R. L. (1981); A Simplified Clear Sky Model for Direct and Diffuse Insolation on Horizontal Surfaces; Solar Energy Research Institute; SERI/TR-642-761
- Blakelock, J.H. (1991); Automatic Control of Aircraft and Missiles – Second Edition; Wiley InterScience; ISBN – 0471506516; Hoboken, NJ, USA
- Britting, K.R.( 1971); Inertial Navigation Systems Analysis; Wiley Interscience; ISBN – 047110485X; Hoboken, NJ, USA
- Caballero, F.; Merino, L.; Ferruz, L. & Ollero, A. (2005); A visual odometer without 3D reconstruction for aerial vehicles. Applications to building inspection, *Proceedings of the 2005 IEEE International Conference on Robotics and Automation* Barcelona, Spain
- Casbeer, D.W. & Li,S.M.(2005); Forest fire monitoring with multiple small UAVs, *Proceedings of the 2005 American Control Conference*, June 8-10, 2005, Portland, USA, pp.3530-3535
- Conway, B. E. (1999); Electrochemical Supercapacitors: Scientific Fundamentals and Technological Applications; Springer; ISBN-10: 0306457369, 978-0306457364
- Coradeschi, S.; Karlsson, L. & Nordberg, K. (1999); Integration of vision and decision-making in an autonomous airborne vehicle for traffic surveillance, *Computer Vision systems*, Springer, Berlin/Heidelberg
- Cramer, M. (2001); On the use of Direct Georeferencing in Airborne Photogrammetry, *Proceedings of the 3rd. International Symposium on Mobile Mapping Technology*, January 2001, Cairo
- Dahlgren, J.W. (2006); Real Options and Value Driven in Spiral Development, *Proceedings of the CCRTS 2006*, March 31, 2006
- Department of Defence (2005); Unmanned Aircraft Systems Roadmap: 2005 – 2030,
- Doherty, P. (2004); Advanced Research with Autonomous Unmanned Aerial Vehicles, *Proceedings on the 9th International Conference on Principles of Knowledge Representation and Reasoning*
- Eisenbeiss, H.& Zhang, L. (2006); Comparison of DSMs generated from mini UAV imagery and terrestrial laser scanner in a cultural heritage application, *Proceedings of IAPRS* vol. 36, part 5, Dresden 25-27 September 2006
- Eisenbeiss, H.; Lambers, K. & Sauerbier, M. (2005); Photogrammetric recording of the archaeological site of Pinchango Alto (Palpa, Peru) using a mini helicopter (UAV), *Proceedings of the 33rd CAA Conference*, Tomar, Portugal, 21-24 March 2005
- Farrell, J.A. & Bath, M. (1999); The Global Positioning System & Inertial Navigation; McGraw Hill; ISBN – 0-07-022045-X; New York, USA
- Farrell, J.A. (2008); *Aided Navigation – GPS with High Rate Sensors*; McGraw Hill; ISBN – 978-0-07-149329-1; New York, USA
- Fisher, R.B.; Dawson-Howe, K.; Fitzgibbon, A.; Robertson, C.& Trucco, E. (2005); *Dictionary of Computer Vision and Image Processing*, John Wiley & Sons, Ltd, England, 2005
- Franklin, G.F. & Powell, J.D. & Emami-Naeini, A. (2006); *Feedback Control of Dynamic Systems* (Fifth edition); Addison-Wesley, ISBN - 978-0131499300, Reading, MA.
- Groves, P.D. (2008); Principles of GNSS, *Inertial and Multisensor Integrated Navigation Systems*; Artech House; ISBN – 1-580-53255-1; Boston, USA
- Heintz, F. & Doherty, P. (2004); A distributed architecture for UAV experimentation, In the *Proceedings of the AAAI Workshop on Anchoring Symbols to Sensor Data*, 2004.

- Horcher, A. & Visser, R.J.M. (2004); Unmanned aerial vehicles: Applications for natural resource management and monitoring, *Proceedings of the Council Of Forest Engineering*, 2004.
- Hornberg, A.(2006); *Handbook of Machine Vision*, Wiley-VCH, 2006, ISBN 3-527-40584-4
- Hruska, R.C.; Lancaster, G.D.; Jerry. H.; Harbour, L. & Cherry, S.J. (2005); Small UAV-Acquired, High-resolution, Georeferenced Still Imagery, *Proceedings of the Wildlife Society 12th Annual Conference*, Baltimore, Maryland,28-30 May 2005
- Joshi, R.; Bose, A. & Breneman, S. (2002); Efficient development of UAV electronics using software frameworks, *Proceedings of the AIAA 1st Conference and Workshop on Unmanned Aerospace Vehicles*, Portsmouth, Virginia, May 20-23, 2002
- Kahn, A.D. (2001); The Design and Development of a Modular Avionics System, *Master Thesis*, Georgia Institute of Technology, April 2001.
- Karr, D.A.; Rodrigues, C.; Krishnamurthy, Y.; Pyarali, I.; Loyall, J.P. & Schantz, R.E.(2001); Application of the QuO Quality-of-Service Framework to a Distributed Video Application, *Proceedings of the Third International Symposium on Distributed Objects and Applications (DOA'01)*, pp. 299, 2001.
- Kim, Z.W. (2005); Realtime road detection by learning from one example, *Proceedings of the Seventh IEEE Workshops on Application of Computer Vision*, 2005. vol.1, pp.455-460, 5-7 Jan. 2005
- Kontitsis, M.; Valavanis, K.P. & Tsourveloudis, N. (2004); A UAV Vision System for Airborne Surveillance, *Proceedings of IEEE International Conference on ICRA '04*, pp. 77-83, 26 April-1 May 2004
- Legat, K. & Skaloud, J. (2006); Reliability of direct georeferencing - A case study on practical problems and solutions, *Report to EuroSDR Commission*, 2006
- Lewis, F.L. & Xie, L. & Popa, D. (2008); Optimal and Robust Estimation with an Introduction to Stochastic Control Theory; Taylor & Francis Group LLC; ISBN - 0-849-39008-7; Boca Raton, FL, USA
- Li, Y.; Atmosukarto, U.; Kobashi, M.; Yuen, J. & Shapiro, L.G. (2005); Object and event recognition for aerial surveillance, *Proceedings- SPIE the international society for optical engineering*, 2005, vol. 5781, pp. 139-149
- Luque, A. & Hegedus, S. (2003); *Handbook of Photovoltaic Science and Engineering*; John Wiley & Sons; ISBN 0471491969, 9780471491965; Hoboken, NJ, USA
- Maybeck, P.S. (1994 - reprint); *Stochastics Models, Estimation, and Control - Volume 1*; Navtech Books & Software Store;
- McRuer, D. & Ashkenas, I. & Graham, D. (1973); *Aircraft Dynamics and Automatic Control*; Princeton University Press; ISBN - 0691024405; Princeton, NJ, USA
- Merino, L. & Ollero, A. (2002); Computer vision techniques for fire monitoring using aerial images, *Proceedings of IECON 02 (28th Annual Conference of the Industrial Electronics Society)*, vol.3, pp.2214-2218, 5-8 Nov. 2002
- Merino, L.; Caballero, F.; Martinez-de Dios, J.R.; Ferruz, J. & Ollero, A. (2006); A cooperative perception system for multiple UAVs: application to automatic detection of forest fires, *Journal of Field Robotics*, vol.23, issue 3-4, pp.165-184, 2006
- Muneer, T.; Gueymard, C. & Kambezidis, H. (2004); *Solar Radiation and Daylight Models*; Butterworth-Heinemann; ISBN 0750659742, 9780750659741

- Niranjan, S.; Gupta, G.; Sharma, N.; Mangal, M. & Singh, V. (2007); Initial Efforts toward Mission-specific Imaging Surveys from Aerial Exploring Platforms, *Proceedings of the Map World Forum*, January 22 - 25, 2007, Hyderabad, India.
- Nonami, K. (2007); Prospect and Recent Research & Development for Civil Use Autonomous Unmanned Aircraft as UAV and MAV, *Journal of System Design and Dynamics*, Vol.1, No.2 Special Issue on New Trends of Motion and Vibration Control pp.120-128, 2007
- Nordberg, K.; Doherty, P.; Farneback, G.; Forssen, P.; Granlund, G.; Moe, A. & Wiklund, J.(2002); Vision for a UAV helicopter, *Proceedings of IROS'02, Workshop on aerial robotics*, October, 2002
- Okrent, M.(2004); Civil UAV Activity within the framework of European Commission Research, *Proceedings of the AIAA 3rd "Unmanned Unlimited" Technical Conference, Workshop and Exhibit*, Chicago, Illinois, Sep. 20-23, 2004
- Puri, A. (2004); A survey of Unmanned Aerial Vehicles (UAV) for Traffic Surveillance, *Technical Report 2004*
- Rathinam, S.; Kim, Z.; Soghikian, A. & Sengupta, R. (2005); Vision based following of locally linear structures using an Unmanned Aerial Vehicle, *44th IEEE Conference on Decision and Control*, 2005 and 2005 European Control Conference, pp.6085-6090, 12-15 Dec. 2005
- Rogers, R.M. (2007); *Applied Mathematics in Integrated Navigation Systems - Third Edition*; American Institute of Aeronautics and Astronautics; ISBN - 1-56347-927-3; Reston, VA, USA
- Roskam, J. (1979) ; *Airplane Flight Dynamics and Automatic Flight Controls*; Roskam Aviation and Engineering Corp.; ISBN - 1-884-88517-9; Lawrence, Kans.:
- Sarris, Z.(2001); Survey of UAV applications in Civil Markets, *Proceedings of the 9th Mediterranean Conference on Control and Automation*, Dubrovnik, Croatia, June 27-29, 2001
- Simon, D. (2006); *Optimal State Estimation*; Wiley InterScience; ISBN - 0-471-70858-5; Hoboken, NJ, USA
- Sinha, A. (2007); *Linear Systems - Optimal and Robust Control*; Taylor & Francis Group LLC; ISBN - 0-8493-9217-9; Boca Raton, FL, USA
- Skaloud, J.& Schaer, P.(2003); Towards a More Rigorous Boresight Calibration, *Proceedings of the ISPRS International Workshop on Theory, Technology and Realities of Inertial/GPS/Sensor Orientation*, Commission 1, WG 1/5, Castelldefels, Spain, September 9-12
- Skogestad, S. & Postlethwaite, I. (2005); *Multivariable Feedback Control Analysis and Design*; John Wiley & Sons; ISBN - 0-470-01168-8; Chichester, England
- Stevens, B.L. & Lewis, F.L. (2003); *Aircraft Control and Simulation - Second Edition*; John Wiley & Sons Inc.; ISBN - 0-471-37145-9; Hoboken, NJ, USA
- Titterton, D.H.; & Weston, J.L.( 2004). *Strapdown Inertial Navigation Technology - Second Edition*, American Institute of Aeronautics and Astronautics; ISBN - 1-56347-693-2; Reston, VA, USA
- Valavanis, K.P., (2007) *Advances in Unmanned Aerial Vehicles - State of the Art and the Road to Autonomy*; Springer, ISBN - 978-1-4020-6113-4, Dordrecht, The Netherlands
- Van Schalkwijk, W. A. & Scrosati, B. (2002); *Advances in lithium-ion batteries*; Springer; ISBN 0306473569, 9780306473562

- Veth, M.; Anderson, R.; Webber, F. & Nielsen, M. (2008); Tightly-Coupled INS, GPS, and Imaging Sensors for Precision Geolocation, *Proceedings of the 2008 National Technical Meeting of the Institute of Navigation*, January 28 - 30, 2008, San Diego, California
- Westall, P.; Carnie, R.J.; O'Shea, P.; Hrabar, S. & Walker, R.A. (2007); Vision-based UAV maritime search and rescue using point target detection, *Proceedings of the 12th Australian International Aerospace Congress*, 19-22 March 2007
- Wilson, J.R.(2002); The Incredible Shrinking Sensor, *Military & Aerospace Electronics Magazine*, March 2002
- Wosylus, A. (2008); High-end graphics conquers embedded computing applications, In *Boards & Solutions - The European Embedded Computing Magazine*, Vol.2, pp.6-10, April 2008
- Zarchan, P. & Musoff, H. (2005); *Fundamentals of Kalman Filtering: A Practical Approach - Second Edition*; American Institute of Aeronautics and Astronautics; ISBN - 1-563-47694-0; Reston, VA, USA